

Electrobombas centrífugas normalizadas "EN 733"

 Agua limpia

 Uso industrial

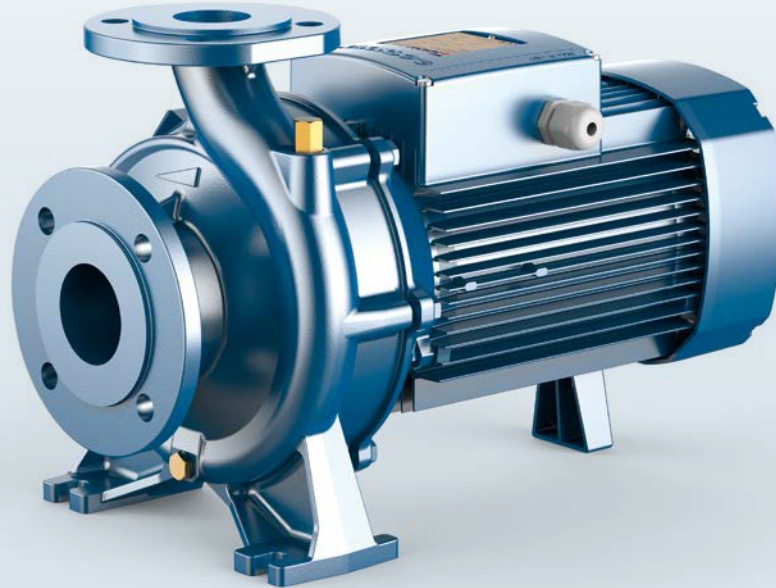

CAMPO DE PRESTACIONES

- Caudal hasta **5750 l/min** (345 m³/h)
- Altura manométrica hasta **98 m**

LÍMITES DE USO

- Altura de aspiración manométrica hasta **7 m**
- Temperatura del líquido de **-10 °C** hasta **+90 °C**
- Temperatura ambiente de **-10 °C** hasta **+40 °C**
- Presión máxima en el cuerpo bomba **10 bar** (PN10)
- Funcionamiento continuo **S1**

EJECUCIÓN Y NORMAS DE SEGURIDAD

EN 60335-1
IEC 60335-1
CEI 61-150

EN 60034-1
IEC 60034-1
CEI 2-3



Dimensiones del cuerpo de la bomba conformes a la norma **EN 733**

CERTIFICACIONES

Empresa con sistema de gestión certificado DNV
ISO 9001: CALIDAD

USOS E INSTALACIONES

- Abastecimiento hídrico
- Presurización
- Irrigación
- Circulación del agua en instalaciones de climatización
- Instalaciones de lavado
- Instalaciones Anti Incendio
- Industria
- Agricultura

La instalación se debe realizar en lugares cerrados, bien aireados y protegidos de la intemperie.

EJECUCIÓN BAJO PEDIDO

- KIT contrabridas completo de tornillos, tuercas y juntas
- Sello mecánico especial
- Otros voltajes
- Para líquidos con temperaturas más altas o más bajas
- Para ambientes con temperaturas más altas o más bajas

GARANTIA

2 años según nuestras condiciones generales de venta

CAMPO DE PRESTACIONES

60 Hz n= 3450 min⁻¹

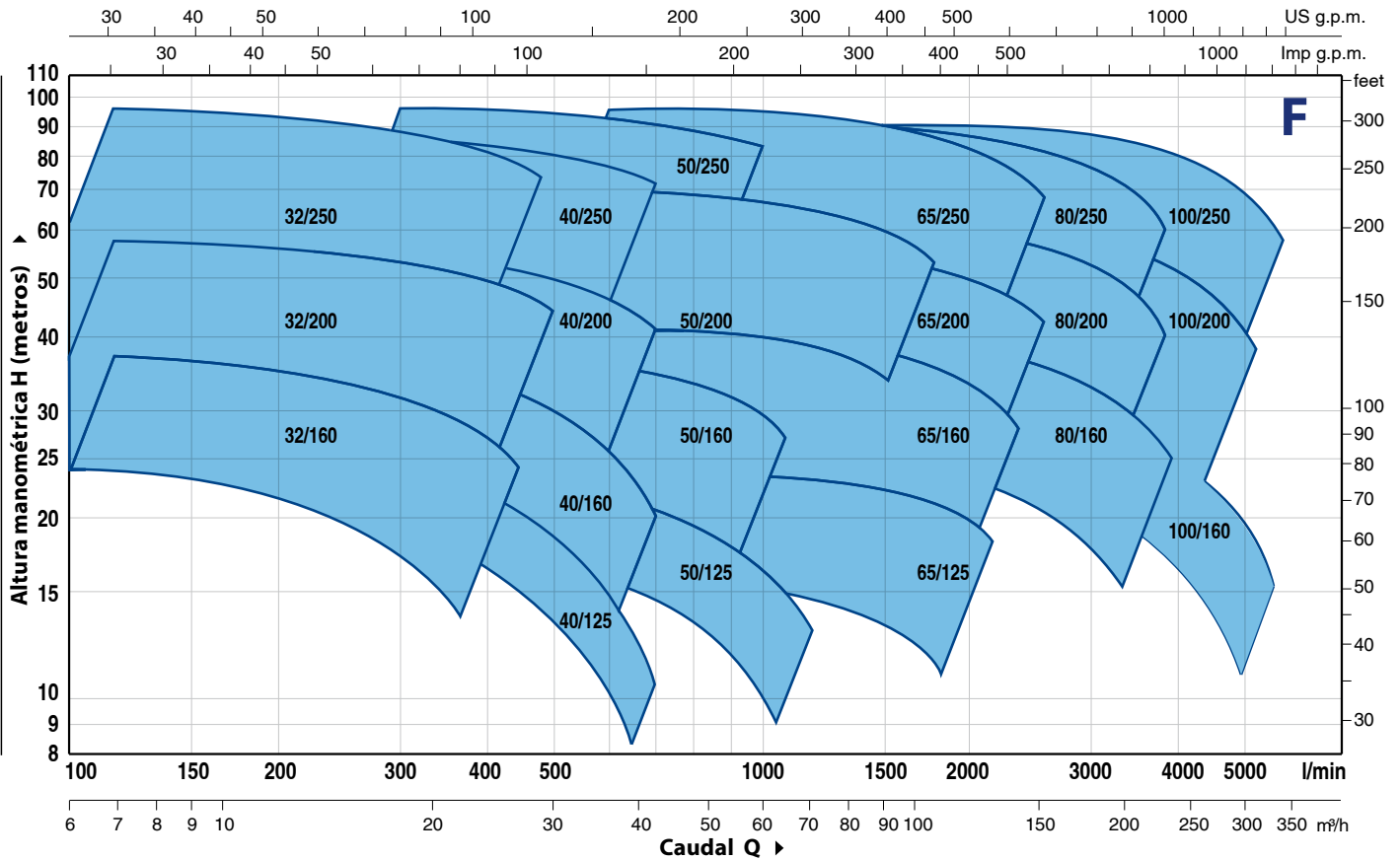

DATOS DE PRESTACIONES

60 Hz n= 3450 min⁻¹

MODELO	POTENCIA (P ₂)		▲	PRESTACIONES	
	kW	HP		Q l/min	H metros
F 32/160C *	1.5	2	IE3	100 – 350	24 – 14
F 32/160B *	2.2	3		100 – 400	30 – 17
F 32/160A *	3	4		100 – 450	37 – 24
F 32/200C *	4	5.5		100 – 450	44 – 31.5
F 32/200B *	5.5	7.5		100 – 500	51 – 36
F 32/200A *	7.5	10		100 – 500	57 – 44
F 32/200BH *	3	4		100 – 300	45 – 37
F 32/200AH *	4	5.5		100 – 320	55 – 44
F 32/250C *	9.2	12.5		100 – 450	75 – 60
F 32/250B *	11	15		100 – 500	87 – 70
F 32/250A *	15	20	100 – 500	97 – 80	
F 40/125C *	1.1	1.5	IE3	100 – 550	16 – 6
F 40/125B *	1.5	2		100 – 600	20.5 – 9
F 40/125A *	2.2	3		100 – 700	26 – 10
F 40/160C *	2.2	3		100 – 600	27 – 14
F 40/160B *	3	4		100 – 600	32 – 20
F 40/160A *	4	5.5		100 – 700	38 – 20
F 40/200B *	5.5	7.5		100 – 700	47 – 28
F 40/200A *	7.5	10		100 – 700	55 – 41
F 40/250C *	9.2	12.5		100 – 700	64 – 47
F 40/250B *	11	15		100 – 700	71 – 55
F 40/250A *	15	20	100 – 700	88 – 72	
F 50/125C *	2.2	3	IE3	300 – 1200	17.5 – 6
F 50/125B *	3	4		300 – 1200	20.7 – 9
F 50/125A *	4	5.5		300 – 1200	23.5 – 13
F 50/160C *	4	5.5		300 – 1000	27 – 16
F 50/160B *	5.5	7.5		300 – 1100	32 – 21
F 50/160A *	7.5	10		300 – 1100	37 – 27
F 50/200C *	11	15		400 – 1700	44 – 30
F 50/200B *	15	20		400 – 1700	52 – 38
F 50/200A *	18.5	25		400 – 1800	61 – 45
F 50/200AR *	22	30		400 – 1800	69 – 53
F 50/250D *	9.2	12.5	300 – 900	51 – 32	
F 50/250C *	11	15	300 – 900	59 – 42	
F 50/250B *	15	20	300 – 1000	72 – 59	
F 50/250A *	18.5	25	300 – 1000	85 – 73	
F 50/250AR *	22	30	300 – 1000	95 – 83	

MODELO	POTENCIA (P ₂)		▲	PRESTACIONES	
	kW	HP		Q l/min	H metros
F 65/125C *	4	5.5	IE3	600 – 1800	16 – 11
F 65/125B *	5.5	7.5		600 – 2000	18 – 13
F 65/125A *	7.5	10		600 – 2200	23 – 18
F 65/160C *	9.2	12.5		600 – 2200	32 – 22
F 65/160B *	11	15		600 – 2400	36.5 – 23
F 65/160A *	15	20		600 – 2400	40.5 – 28
F 65/200B *	15	20		200 – 2400	44 – 30.5
F 65/200A *	18.5	25		200 – 2500	50 – 36.5
F 65/200AR *	22	30		200 – 2600	57 – 42
F 65/250C *	30	40		400 – 2350	76 – 53
F 65/250B *	37	50	400 – 2500	87 – 62	
F 65/250A *	45	60	400 – 2600	95 – 68	
F 80/160D *	11	15	IE3	500 – 4000	25 – 10
F 80/160C *	15	20		500 – 4000	30 – 15
F 80/160B *	18.5	25		500 – 4000	35 – 20
F 80/160A *	22	30		500 – 4000	40 – 25
F 80/200B *	30	40		500 – 3650	56 – 34.5
F 80/200A *	37	50		500 – 3900	62 – 40
F 80/250B *	45	60		600 – 3600	77 – 54
F 80/250A *	55	75		600 – 3900	88.5 – 60
F 100/160A *	22	30		1000 ÷ 5500	40 – 16.5
F 100/200C *	30	40		833 – 4650	51 – 28
F 100/200B *	37	50	833 – 4900	57 – 33	
F 100/200A *	45	60	833 – 5250	63 – 38	
F 100/250B *	55	75	800 – 5150	75 – 48	
F 100/250A *	75	100	800 – 5750	89 – 58	

Q = Caudal

H = Altura manométrica total

Tolerancia de las curvas de prestación según EN ISO 9906 Grado 3B.

▲ Clase de rendimiento del motor trifásico (IEC 60034-30-1)

* Modelos solicitados bajo pedido

F32/160

CURVAS Y DATOS DE PRESTACIONES

60 Hz n = 3450 min⁻¹ HS = 0 m

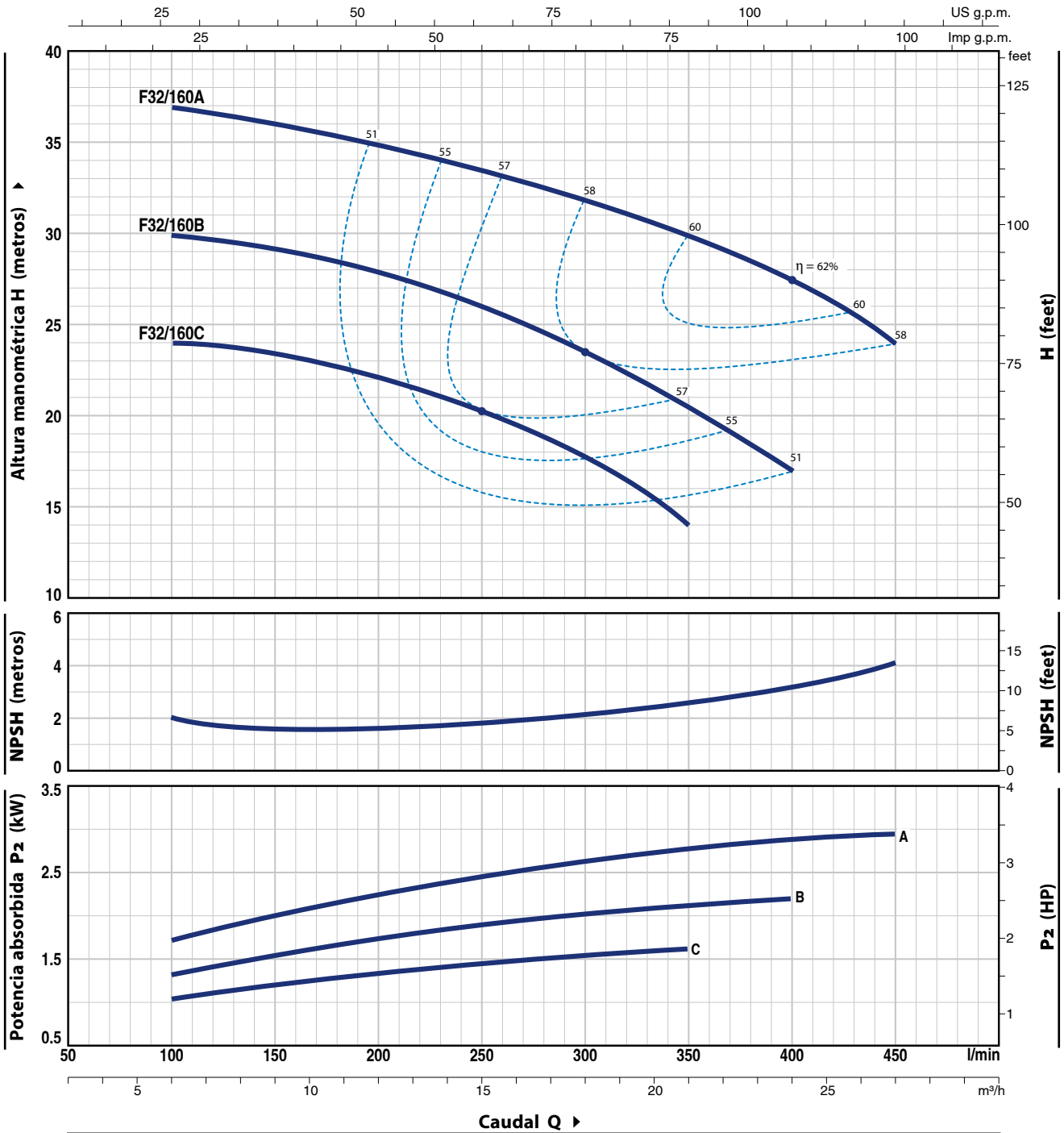

MODELO		POTENCIA (P ₂)		Q	Caudal												
Monofásica	Trifásica	kW	HP		m ³ /h	0	6	9	12	15	18	21	24	27			
				l/min	0	100	150	200	250	300	350	400	450				
Fm 32/160C *	F 32/160C *	1.5	2	H metros	25	24	23.5	22	20.5	18	14						
Fm 32/160B *	F 32/160B *	2.2	3		31	30	29	28	26	23.5	20.5	17					
-	F 32/160A *	3	4		38	37	36	35	33.5	31.5	30	27.5	24				

Q = Caudal H = Altura manométrica total HS = Altura de aspiración

Tolerancia de las curvas de prestación según EN ISO 9906 Grado 3B.

* Modelos solicitados bajo pedido

CURVAS Y DATOS DE PRESTACIONES

60 Hz n = 3450 min⁻¹ HS = 0 m

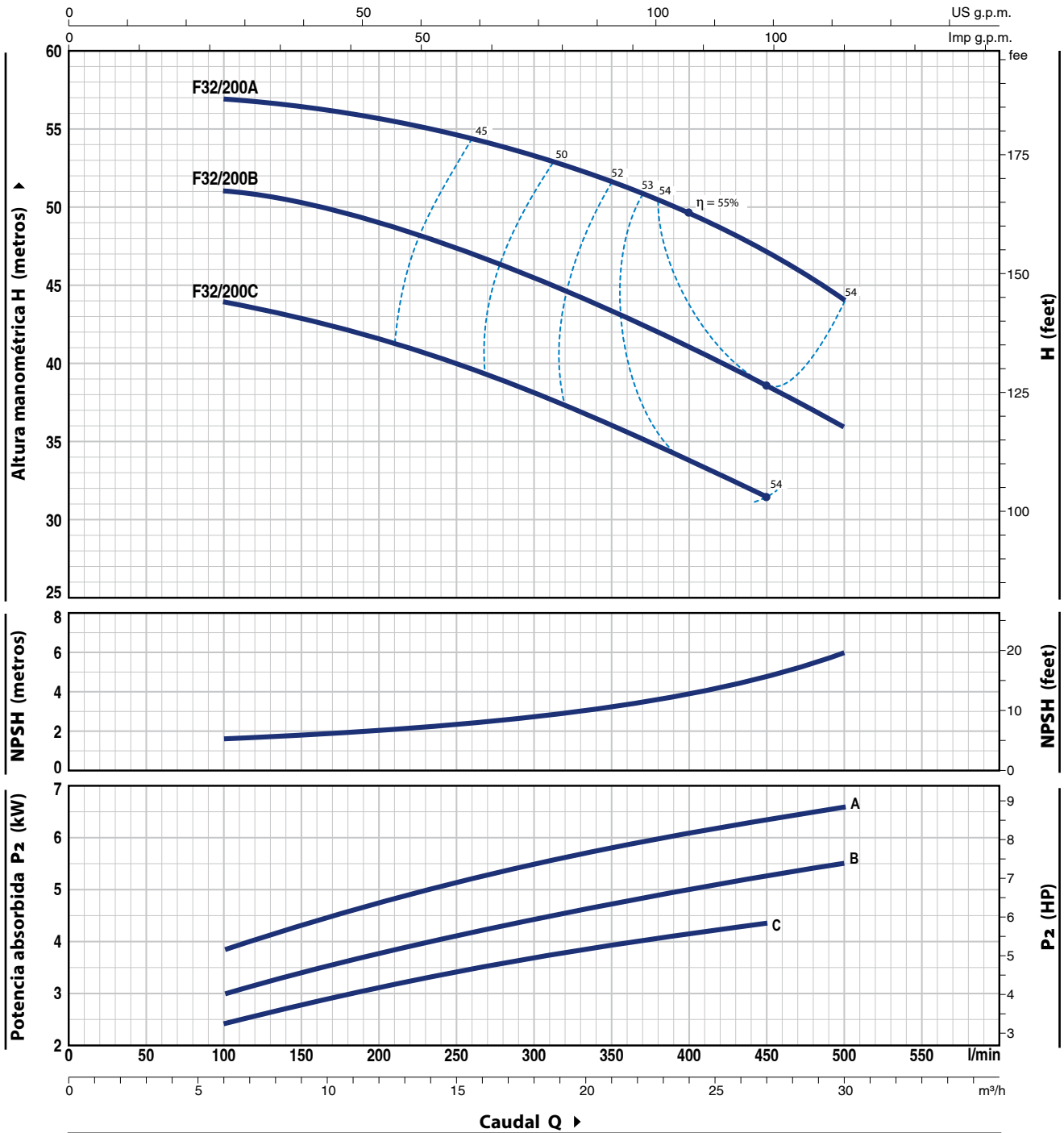

MODELO	POTENCIA (P ₂)		Q	Caudal											
	kW	HP		m ³ /h	0	6	9	12	15	18	21	24	27	30	
Trifásica			l/min	0	100	150	200	250	300	350	400	450	500		
F 32/200C *	4	5.5	H metros	46	44	43	41.5	40	38	36	34	31.5			
F 32/200B *	5.5	7.5		52	51	50.5	49	47	45	43	41	38.5	36		
F 32/200A *	7.5	10		60	57	56.5	56	55	53.5	52	50	47	44		

Q = Caudal H = Altura manométrica total HS = Altura de aspiración

Tolerancia de las curvas de prestación según EN ISO 9906 Grado 3B.

* Modelos solicitados bajo pedido

F32/200H

CURVAS Y DATOS DE PRESTACIONES

60 Hz n = 3450 min⁻¹ HS = 0 m

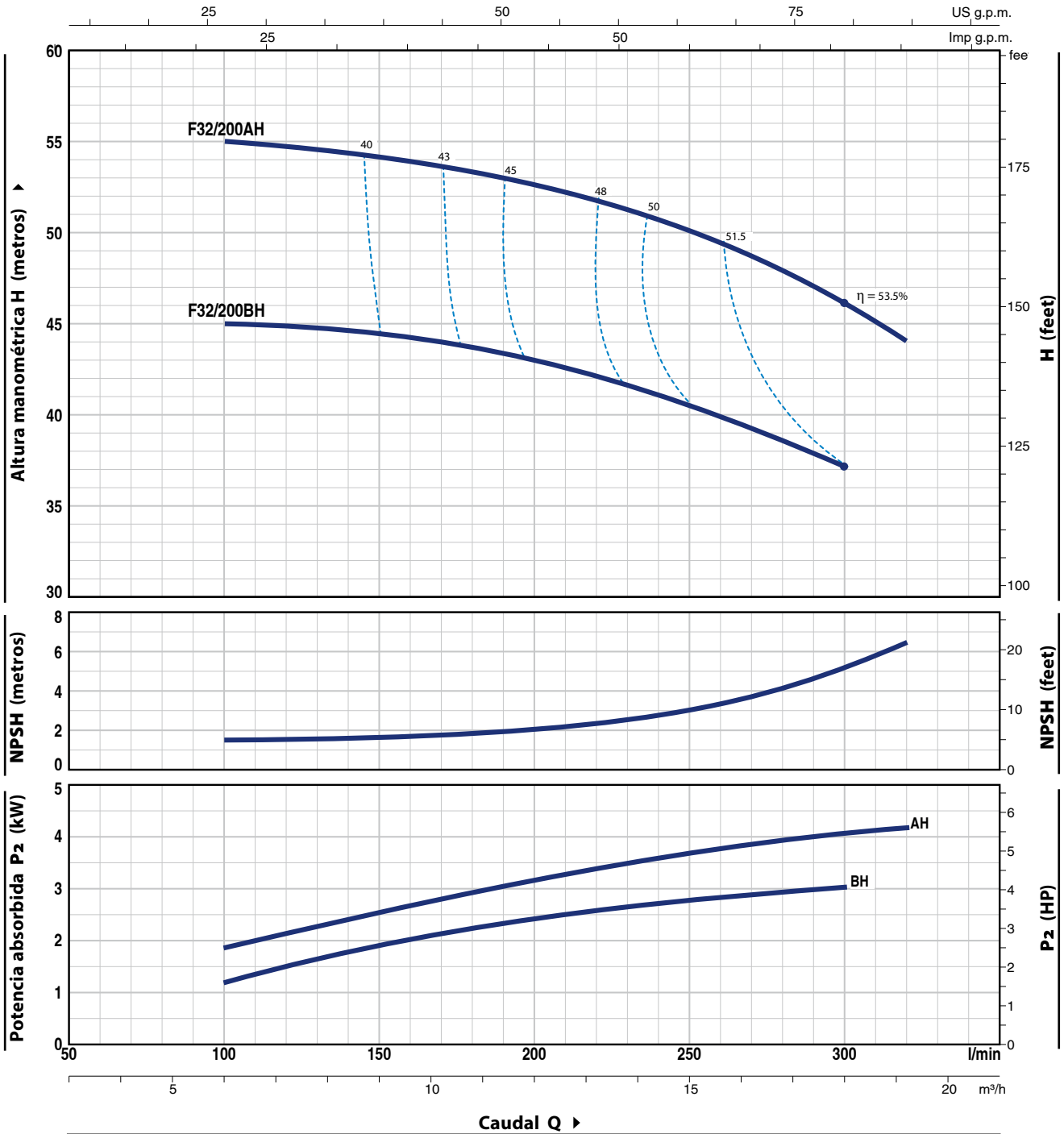

MODELO	POTENCIA (P ₂)		Q	H metros						
	kW	HP		0	6	9	12	15	18	19.2
Trifásica			$\frac{m^3}{h}$	0	6	9	12	15	18	19.2
			l/min	0	100	150	200	250	300	320
F 32/200BH *	3	4	H metros	47	45	44.5	43	40.5	37	
F 32/200AH *	4	5.5		57	55	54	52.5	50	46	44

Q = Caudal H = Altura manométrica total HS = Altura de aspiración

Tolerancia de las curvas de prestación según EN ISO 9906 Grado 3B.

* Modelos solicitados bajo pedido

CURVAS Y DATOS DE PRESTACIONES

60 Hz n = 3450 min⁻¹ HS = 0 m

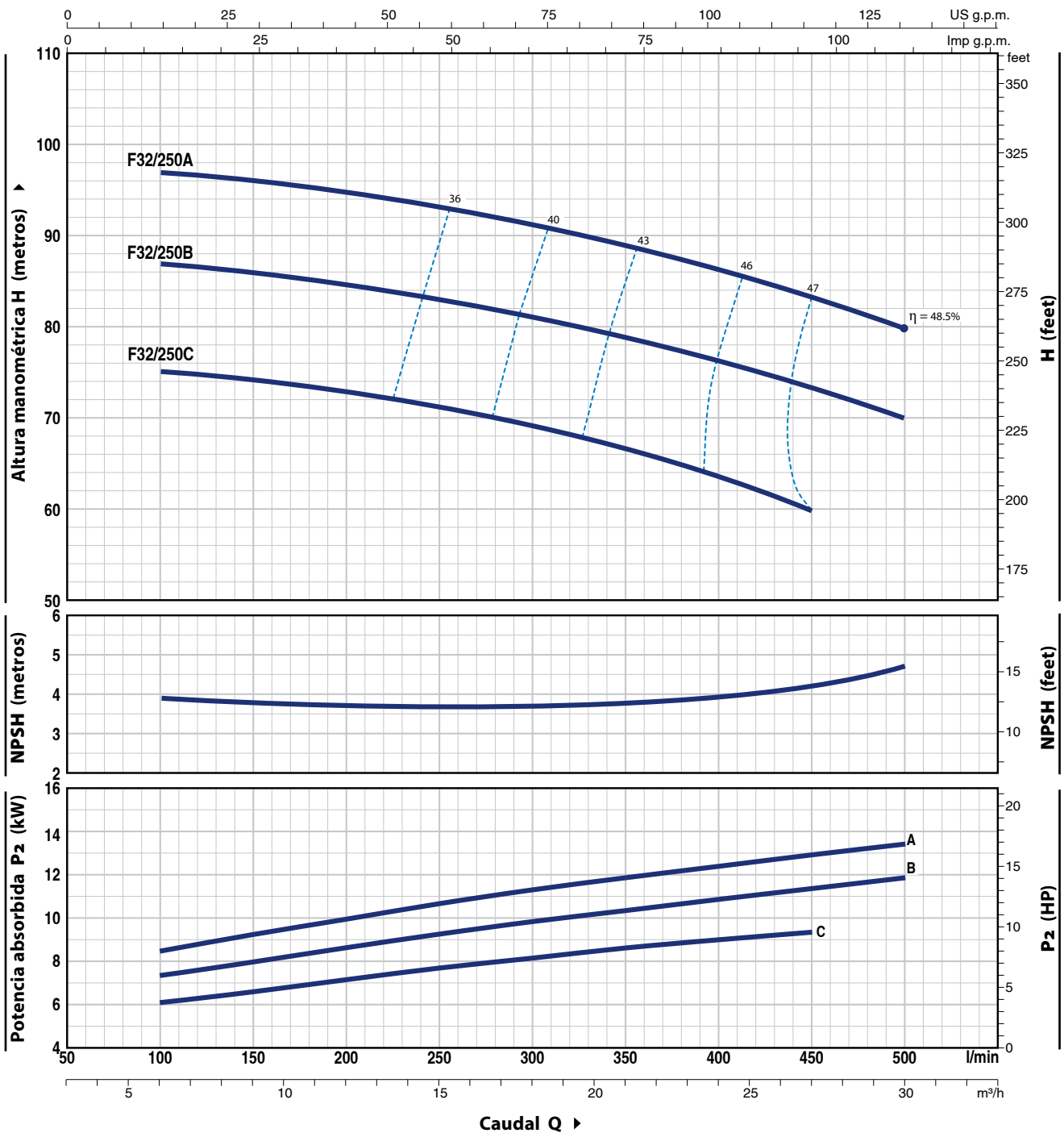

MODELO	POTENCIA (P ₂)		Q	m ³ /h												
	kW	HP		0	6	9	12	15	18	21	24	27	30			
Trifásica			l/min	0	100	150	200	250	300	350	400	450	500			
F 32/250C *	9.2	12.5	H metros	76	75	74.5	73	71.5	69.5	67	64	60				
F 32/250B *	11	15		88	87	86	85	83	81	79	76.5	73.5	70			
F 32/250A *	15	20		98	97	96	95	93	91	89	86.5	83.5	80			

Q = Caudal H = Altura manométrica total HS = Altura de aspiración

Tolerancia de las curvas de prestación según EN ISO 9906 Grado 3B.

* Modelos solicitados bajo pedido

F40/125

CURVAS Y DATOS DE PRESTACIONES

60 Hz n = 3450 min⁻¹ HS = 0 m

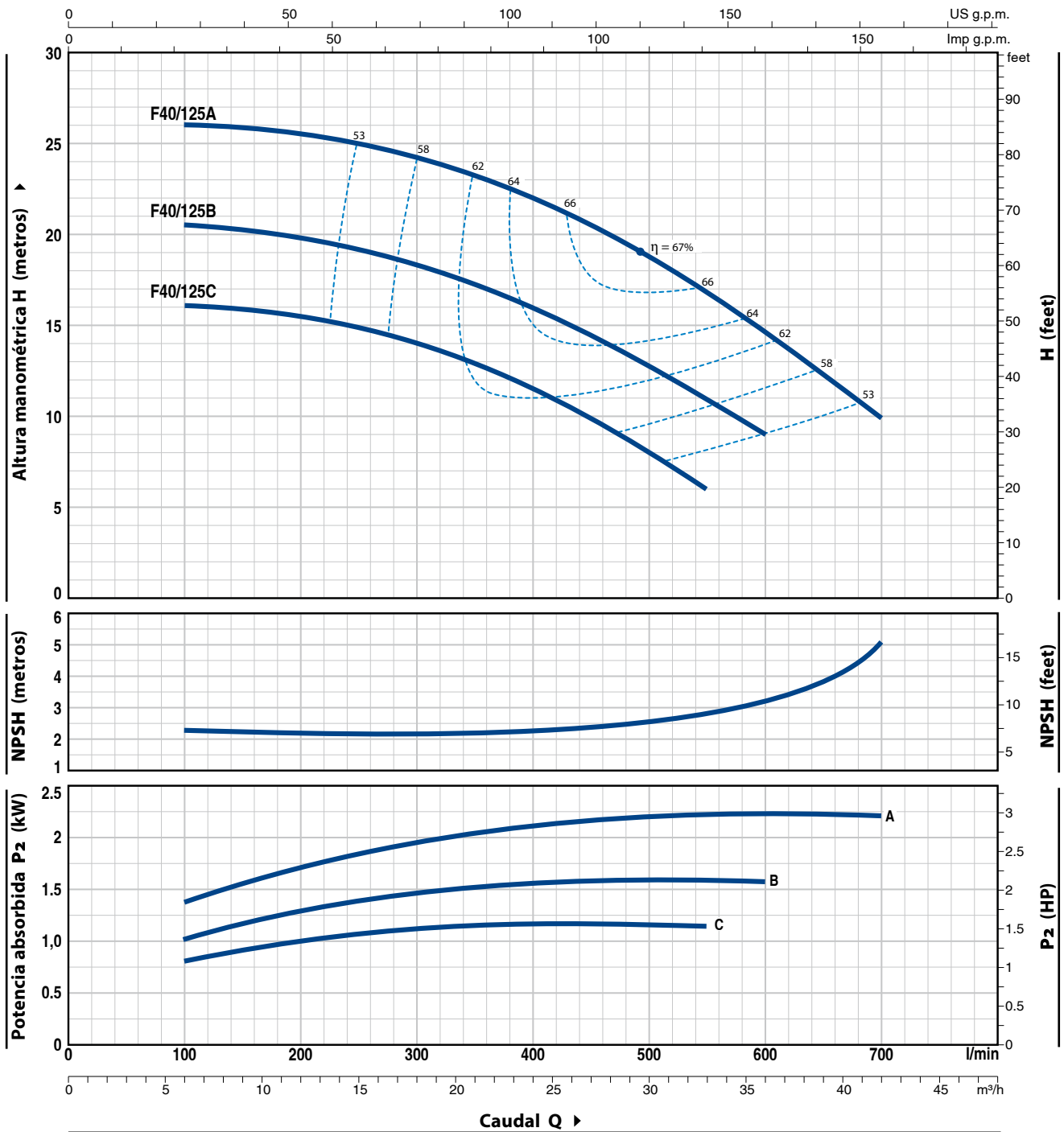

MODELO		POTENCIA (P ₂)		Q	Flow Rate (l/min)													
Monofásica	Trifásica	kW	HP		0	6	12	18	24	30	33	36	39	42				
Fm 40/125C *	F 40/125C *	1.1	1.5	H metros	0	100	200	300	400	500	550	600	650	700				
Fm 40/125B *	F 40/125B *	1.5	2		16	16	15.5	14	11.5	8	6							
Fm 40/125A *	F 40/125A *	2.2	3		20.5	20.5	19.8	18.5	16	12.8	11	9						
					26	26	25.5	24	22	18.5	17	14.5	12.5	10				

Q = Caudal H = Altura manométrica total HS = Altura de aspiración

Tolerancia de las curvas de prestación según EN ISO 9906 Grado 3B.

* Modelos solicitados bajo pedido

CURVAS Y DATOS DE PRESTACIONES

60 Hz n = 3450 min⁻¹ HS = 0 m

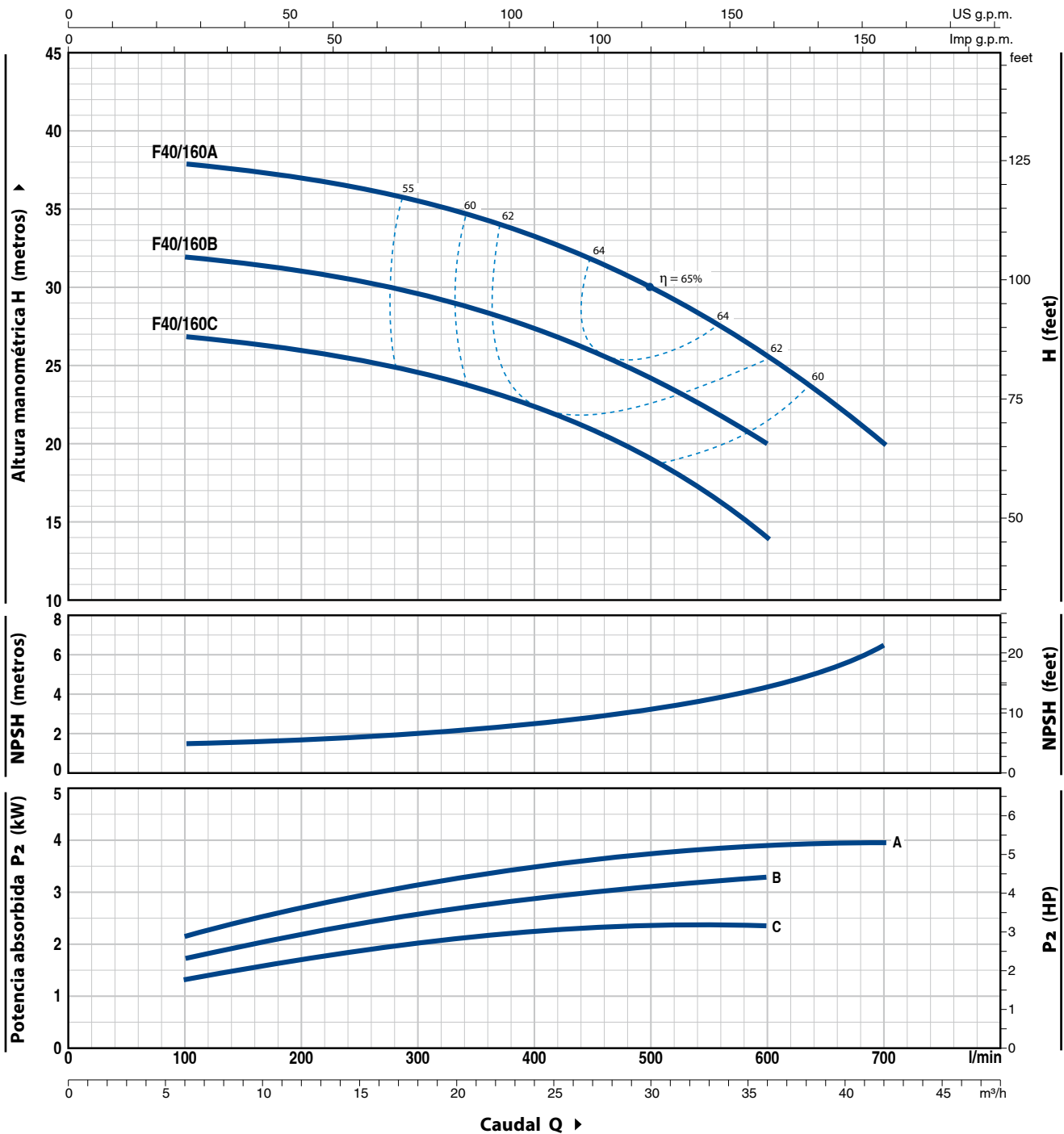

MODELO		POTENCIA (P ₂)		Q m ³ /h l/min	0	6	9	12	15	18	24	30	36	42
Monofásica	Trifásica	kW	HP		0	100	150	200	250	300	400	500	600	700
Fm 40/160C *	F 40/160C *	2.2	3	H metros	27	27	26.5	26	25.5	25	22.5	19	14	
-	F 40/160B *	3	4		32	32	31.5	31	30.5	30	27.5	24	20	
-	F 40/160A *	4	5.5		38	38	37.8	37	36.5	36	33.5	30	26	20

Q = Caudal H = Altura manométrica total HS = Altura de aspiración

Tolerancia de las curvas de prestación según EN ISO 9906 Grado 3B.

* Modelos solicitados bajo pedido

F40/200

CURVAS Y DATOS DE PRESTACIONES

60 Hz n = 3450 min⁻¹ HS = 0 m

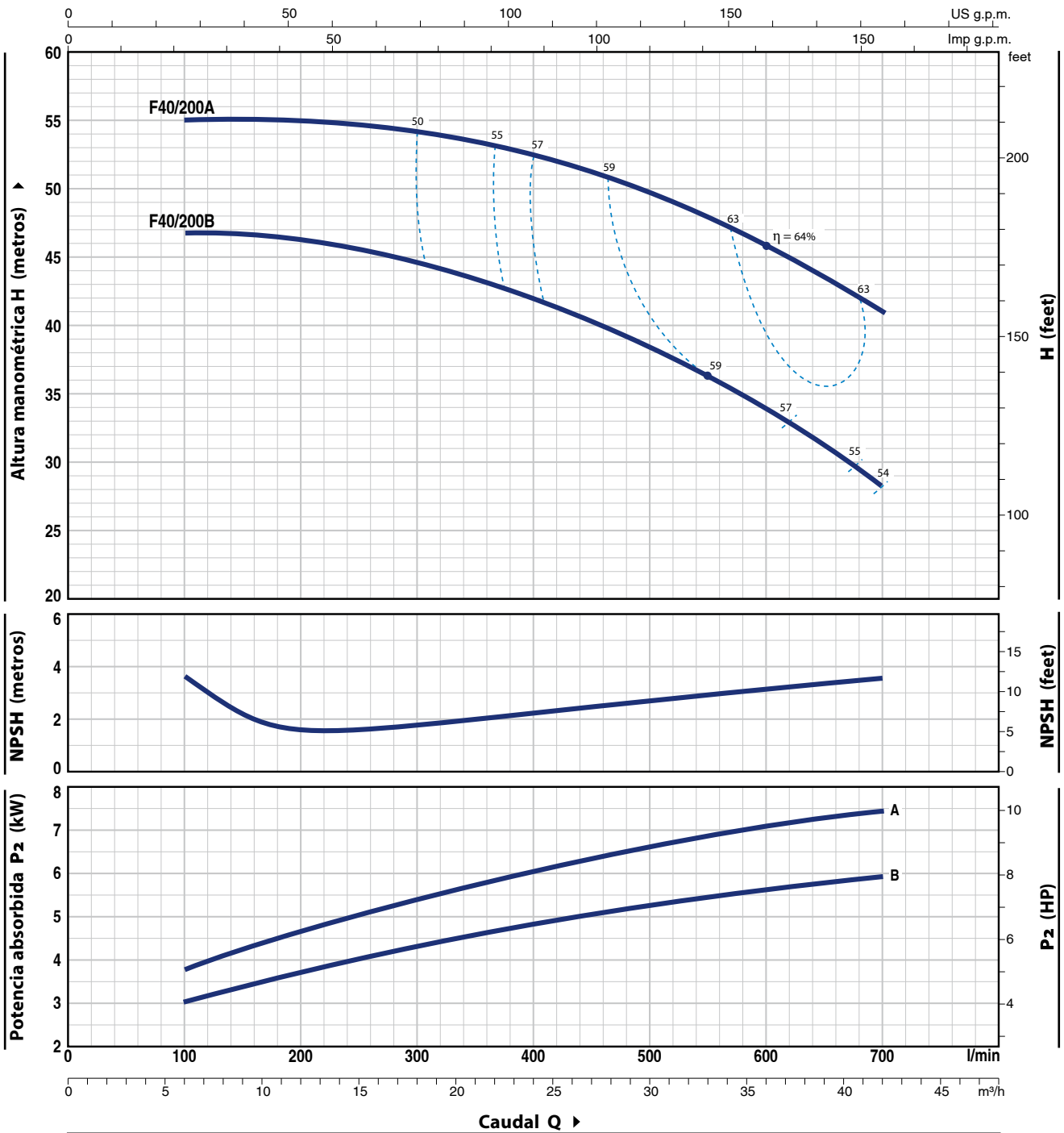

MODELO	POTENCIA (P ₂)		Q	m ³ /h											
	kW	HP		0	6	9	12	15	18	24	30	36	42		
Trifásica			l/min	0	100	150	200	250	300	400	500	600	700		
F 40/200B *	5.5	7.5	H metros	48	47	46.5	46	45.5	44.5	42	38	34	28		
F 40/200A *	7.5	10		56	55	55	55	54.5	54	52.5	49.5	46	41		

Q = Caudal H = Altura manométrica total HS = Altura de aspiración

Tolerancia de las curvas de prestación según EN ISO 9906 Grado 3B.

* Modelos solicitados bajo pedido

CURVAS Y DATOS DE PRESTACIONES

60 Hz n = 3450 min⁻¹ HS = 0 m

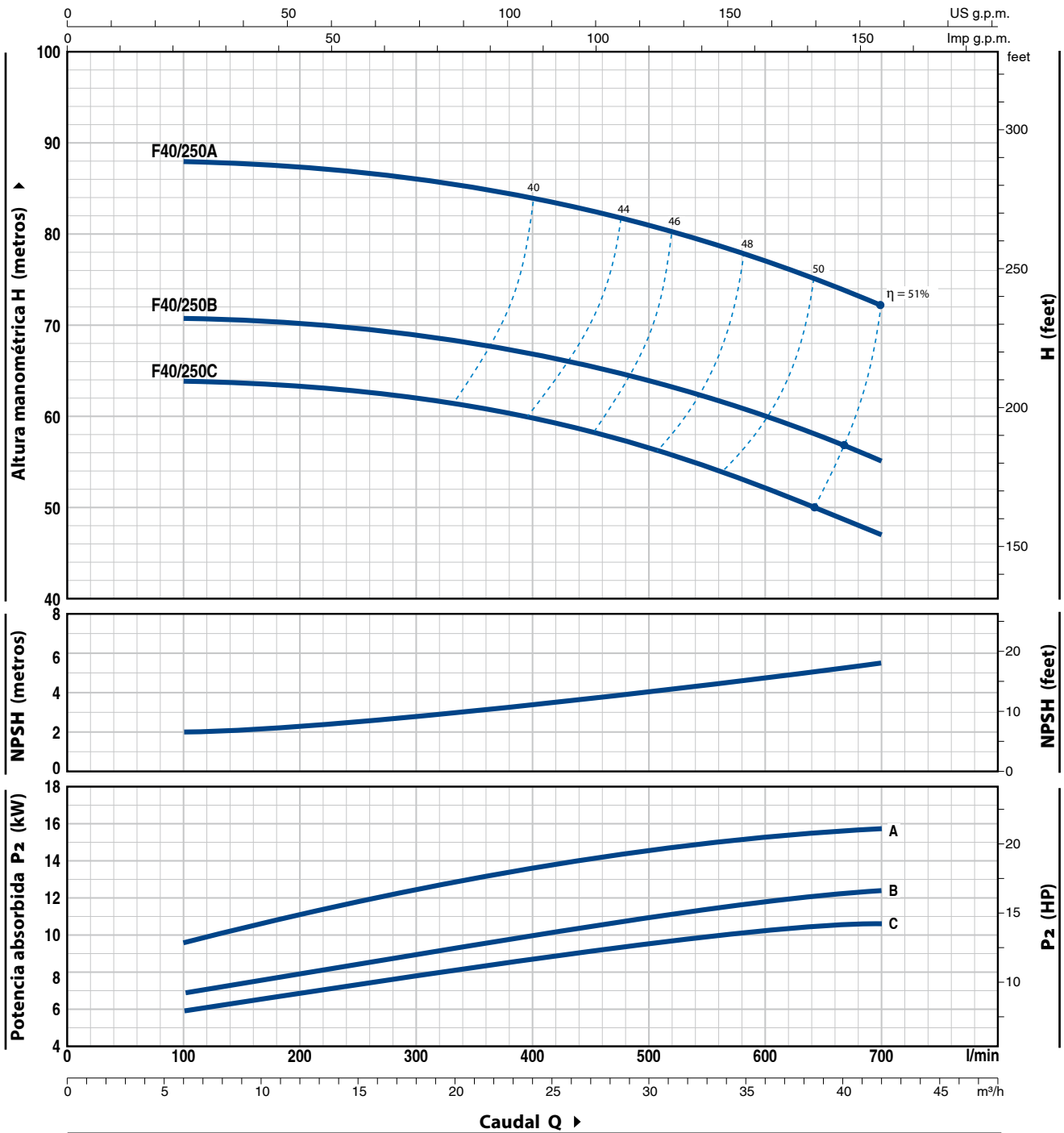

MODELO	POTENCIA (P ₂)		Q	m ³ /h												
	kW	HP		0	6	9	12	15	18	24	30	36	42			
Trifásica			Q	l/min												
				0	100	150	200	250	300	400	500	600	700			
F 40/250C *	9.2	12.5	H metros	64	64	63.5	63	62.5	62	60	56.5	52.5	47			
F 40/250B *	11	15		71	71	70.5	70	69.5	69	67	64	60	55			
F 40/250A *	15	20		88	88	87.5	87	86.5	86	84	81	77	72			

Q = Caudal H = Altura manométrica total HS = Altura de aspiración

Tolerancia de las curvas de prestación según EN ISO 9906 Grado 3B.

* Modelos solicitados bajo pedido

F50/125

CURVAS Y DATOS DE PRESTACIONES

60 Hz n= 3450 min⁻¹ HS= 0 m

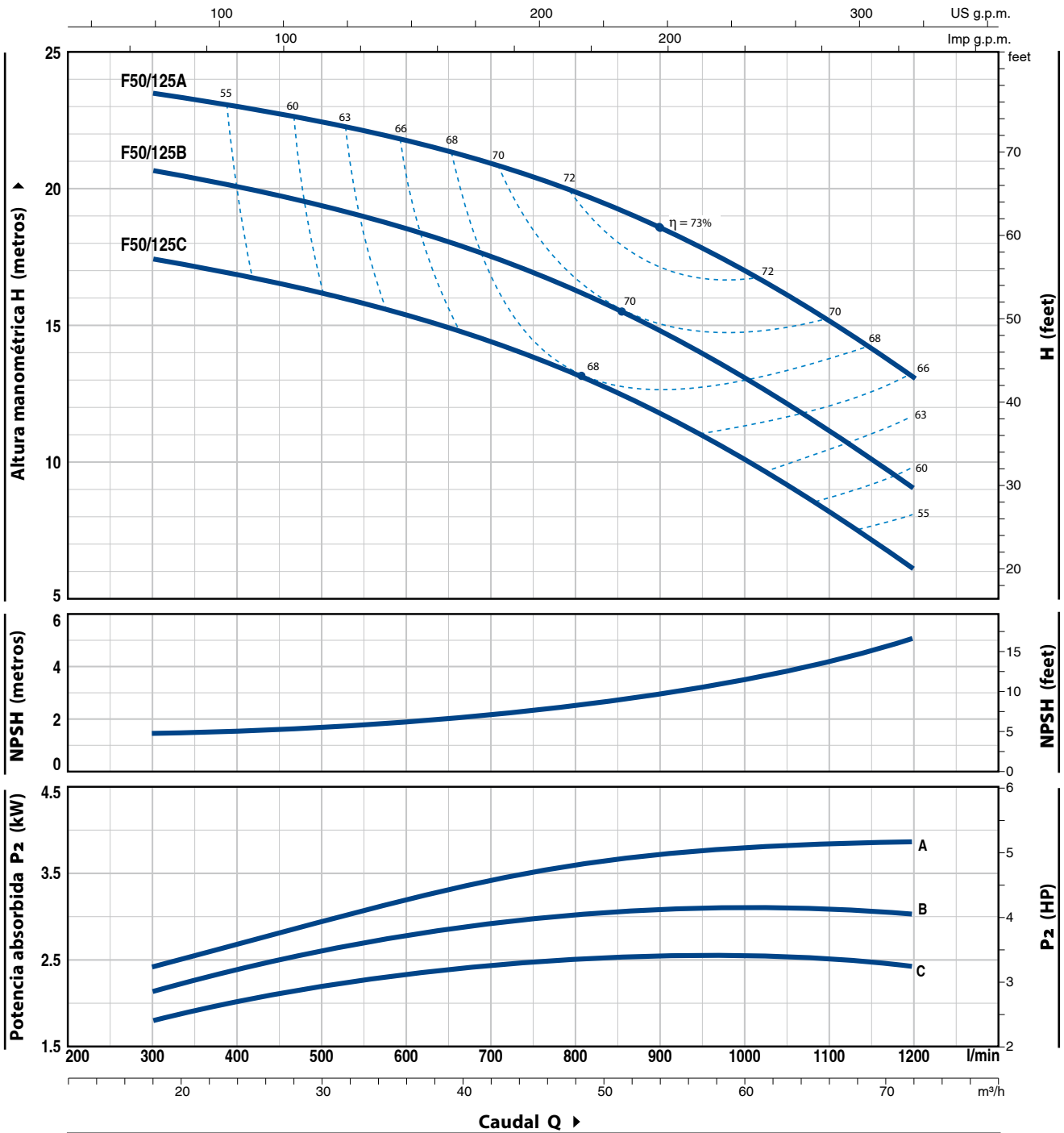

MODELO		POTENCIA (P ₂)		Q	Flow Rate (Q)												
Monofásica	Trifásica	kW	HP		m ³ /h	0	18	24	30	36	42	48	54	60	66	72	
				l/min	0	300	400	500	600	700	800	900	1000	1100	1200		
Fm 50/125C *	F 50/125C *	2.2	3	H metros	18.5	17.5	17	16.5	15.5	14.8	13.5	12	10.5	8.2	6		
-	F 50/125B *	3	4		21.5	20.7	20	19.5	18.8	17.8	16.5	15	13.5	11.2	9		
-	F 50/125A *	4	5.5		24.5	23.5	23	22.5	21.8	20.8	19.5	18.3	16.8	15	13		

Q = Caudal H = Altura manométrica total HS = Altura de aspiración

Tolerancia de las curvas de prestación según EN ISO 9906 Grado 3B.

* Modelos solicitados bajo pedido

CURVAS Y DATOS DE PRESTACIONES

60 Hz n = 3450 min⁻¹ HS = 0 m

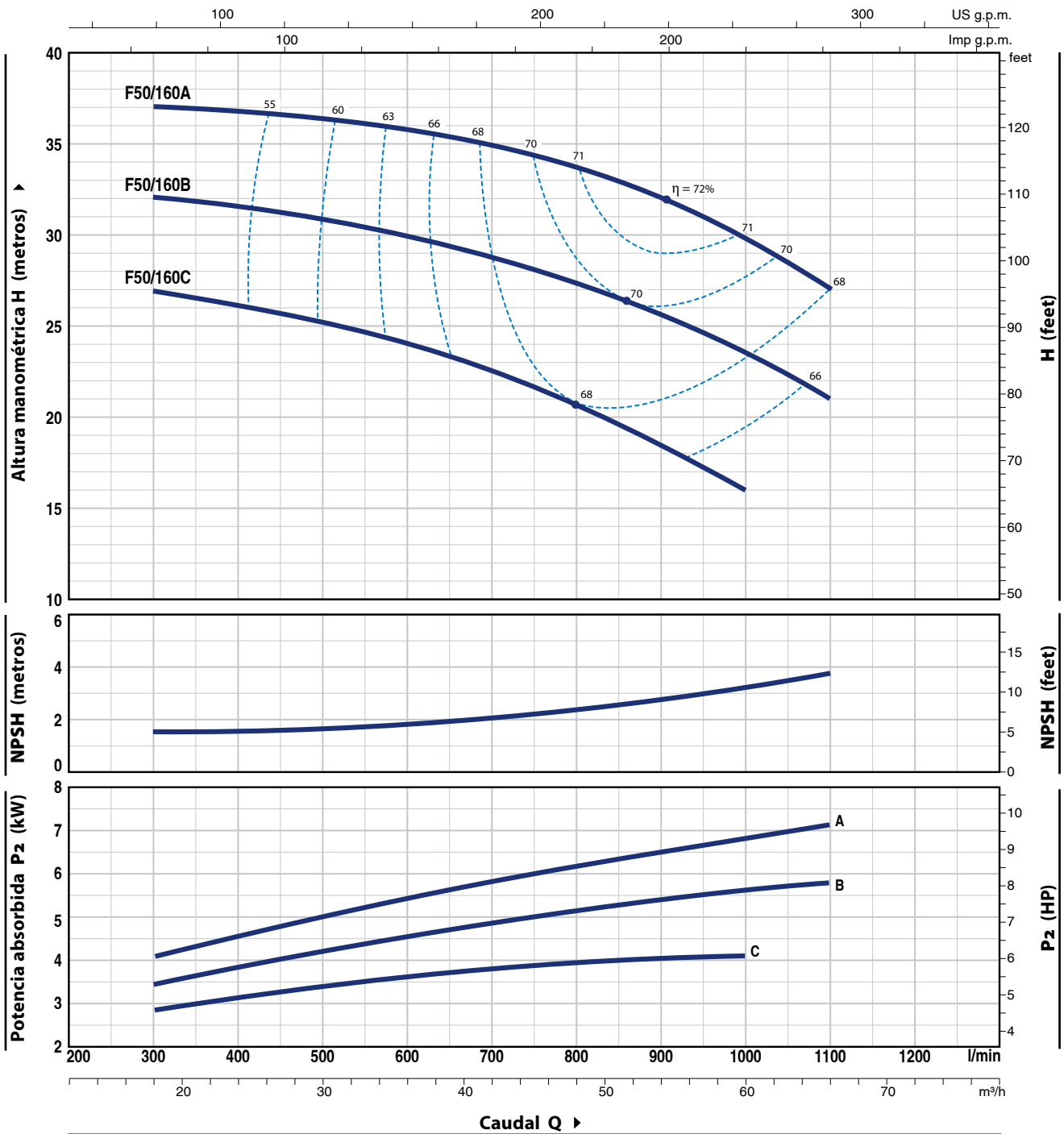

MODELO	POTENCIA (P ₂)		Q	Caudal											
	kW	HP		m ³ /h	0	18	24	30	36	42	48	54	60	66	
Trifásica			l/min	0	300	400	500	600	700	800	900	1000	1100		
F 50/160C *	4	5.5	H metros	27	27	26.5	25	24.5	23	20	18.5	16			
F 50/160B *	5.5	7.5		33	32	31.7	31	30	29	27	26	24	21		
F 50/160A *	7.5	10		38	37	36.8	36.5	36	34	33	32	30	27		

Q = Caudal H = Altura manométrica total HS = Altura de aspiración

Tolerancia de las curvas de prestación según EN ISO 9906 Grado 3B.

* Modelos solicitados bajo pedido

F50/200

CURVAS Y DATOS DE PRESTACIONES

60 Hz n = 3450 min⁻¹ HS = 0 m

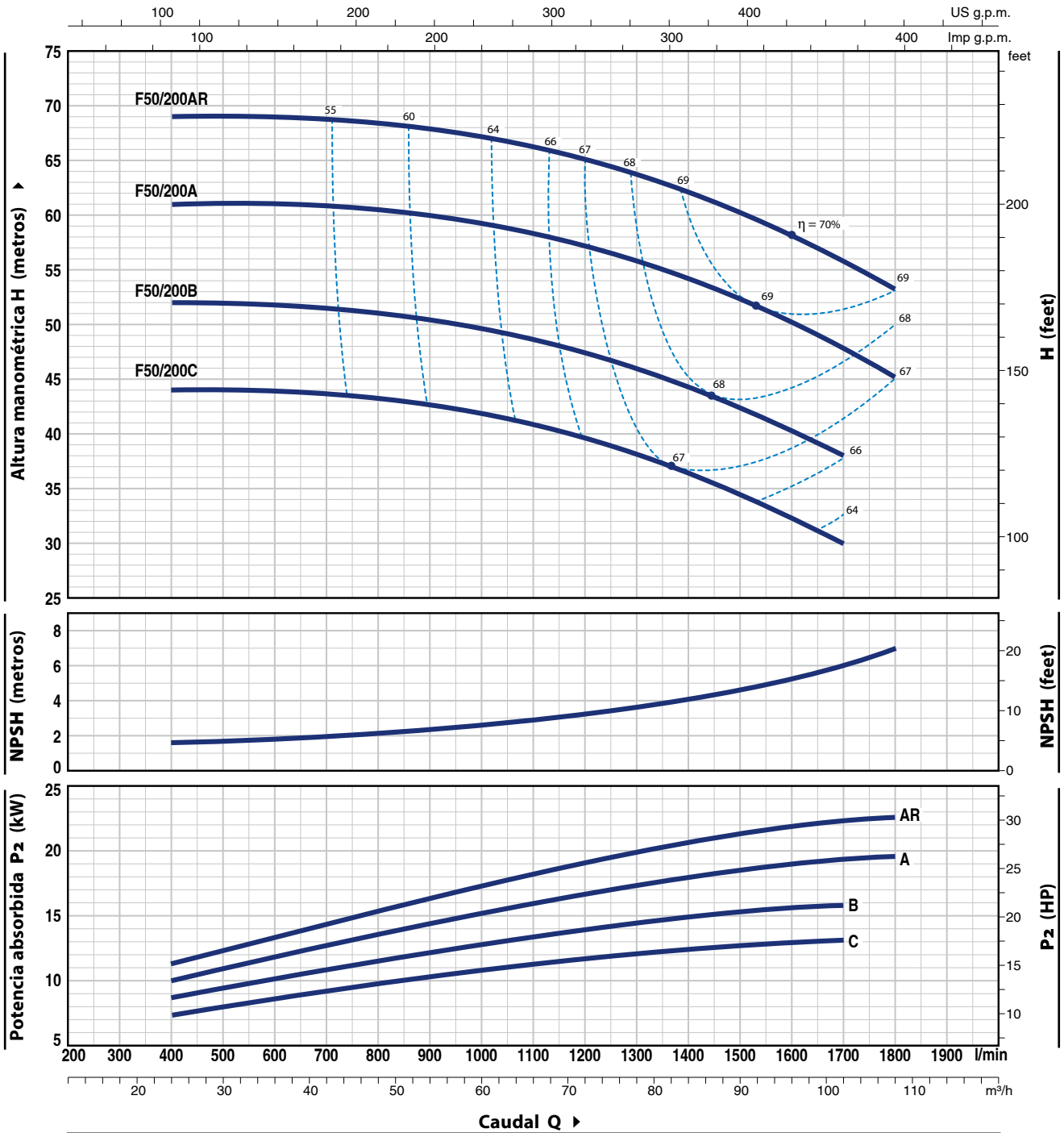

MODELO	POTENCIA (P ₂)		Q m ³ /h l/min	H metros										
	kW	HP		24	36	48	60	72	84	96	102	108		
F 50/200C	11	15	400	44	44	44	42	39	36	33	30			
F 50/200B	15	20	600	52	52	52	50	47	44	40	38			
F 50/200A	18.5	25	800	61	61	60.5	60	57	54	50	48	45		
F 50/200AR	22	30	1000	69	69	68.5	68	65	62	58	56	53		

Q = Caudal H = Altura manométrica total HS = Altura de aspiración

Tolerancia de las curvas de prestación según EN ISO 9906 Grado 3B.

CURVAS Y DATOS DE PRESTACIONES

60 Hz n= 3450 min⁻¹ HS= 0 m

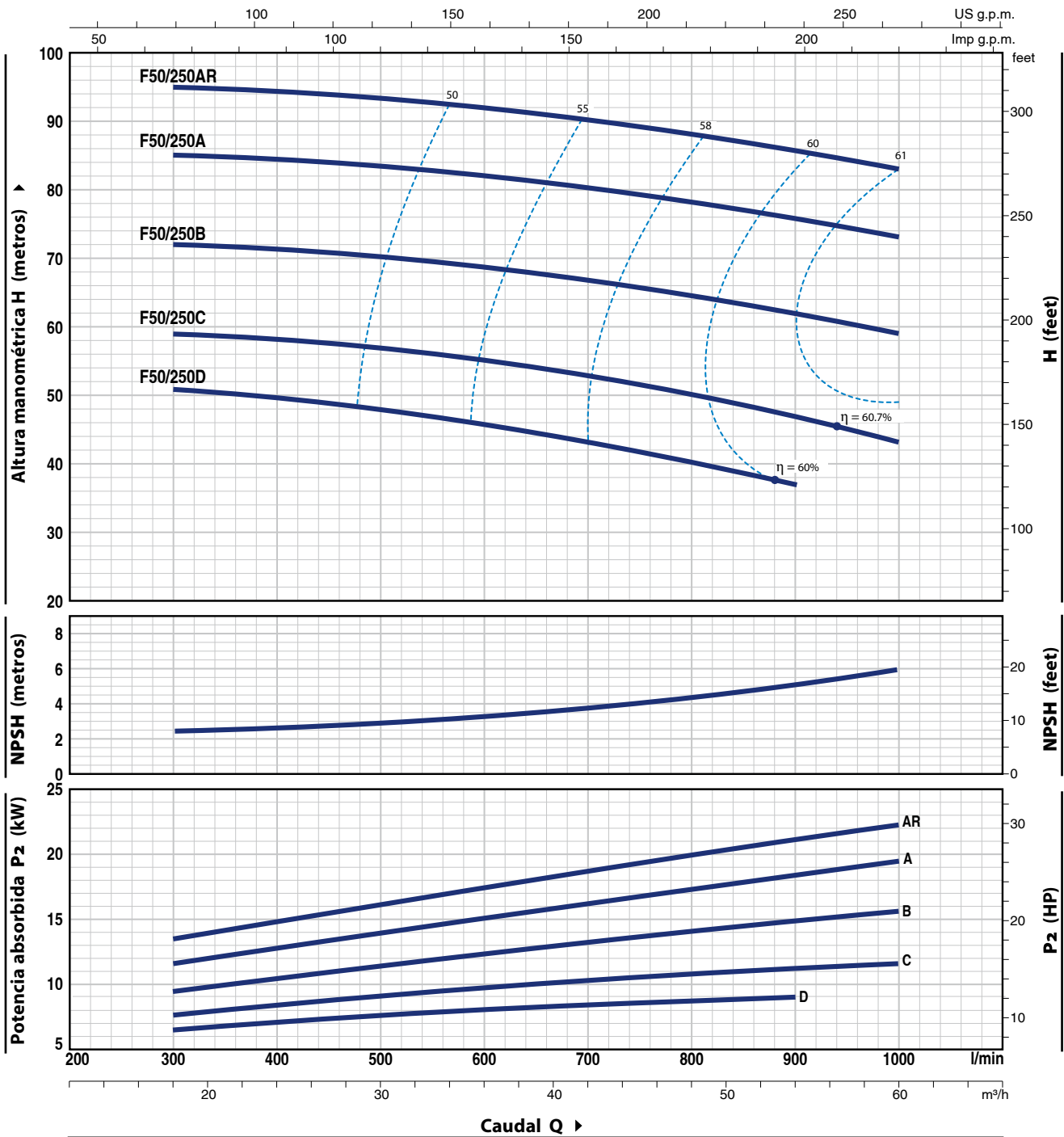

MODELO	POTENCIA (P ₂)		Q	m ³ /h											
	kW	HP		0	18	24	30	36	42	48	54	60			
Trifásica			l/min	0	300	400	500	600	700	800	900	1000			
F 50/250D *	9.2	12.5	H metros	51	51	49	47	44	41	37	32				
F 50/250C *	11	15		59	59	58	57	54	51	47	42				
F 50/250B *	15	20		72	72	71	70	69	67	65	62	59			
F 50/250A *	18.5	25		85	85	84	83	82	80	78	76	73			
F 50/250AR *	22	30		95	95	94	93	92	90	88	86	83			

Q=Caudal H=Altura manométrica total HS= Altura de aspiración

Tolerancia de las curvas de prestación según EN ISO 9906 Grado 3B.

* Modelos solicitados bajo pedido

F65/125

CURVAS Y DATOS DE PRESTACIONES

60 Hz n = 3450 min⁻¹ HS = 0 m

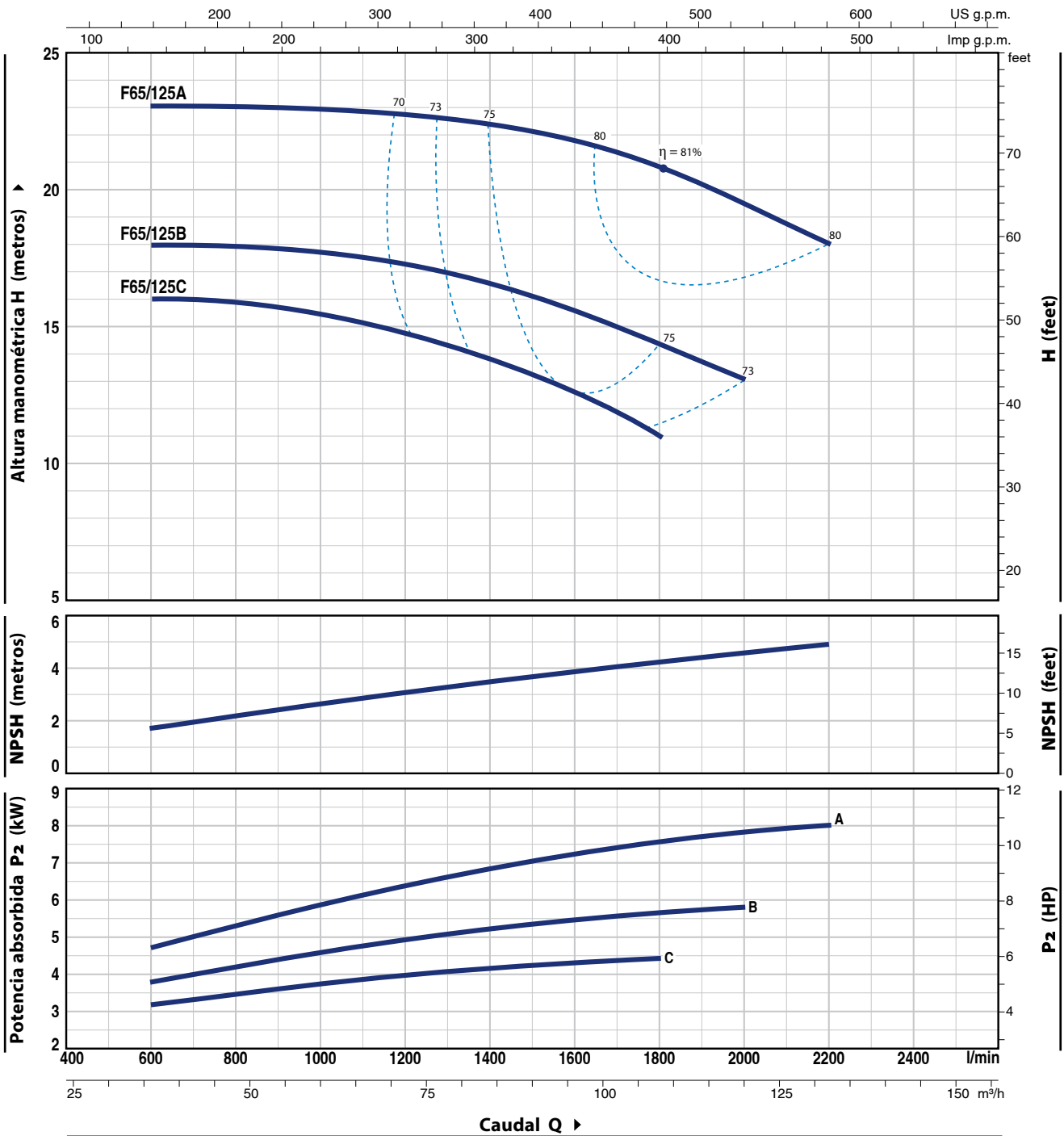

MODELO	POTENCIA (P ₂)		Q	m ³ /h												
	kW	HP		0	36	48	60	72	84	96	108	120	132			
Trifásica			l/min	0	600	800	1000	1200	1400	1600	1800	2000	2200			
F 65/125C *	4	5.5	H metros	16	16	16	15.5	14.5	13.5	12.5	11					
F 65/125B *	5.5	7.5		18	18	18	18	17	16.5	15.5	14.5	13				
F 65/125A *	7.5	10		23	23	23	23	22.5	22.5	22	21	19.5	18			

Q = Caudal H = Altura manométrica total HS = Altura de aspiración

Tolerancia de las curvas de prestación según EN ISO 9906 Grado 3B.

* Modelos solicitados bajo pedido

CURVAS Y DATOS DE PRESTACIONES

60 Hz n = 3450 min⁻¹ HS = 0 m

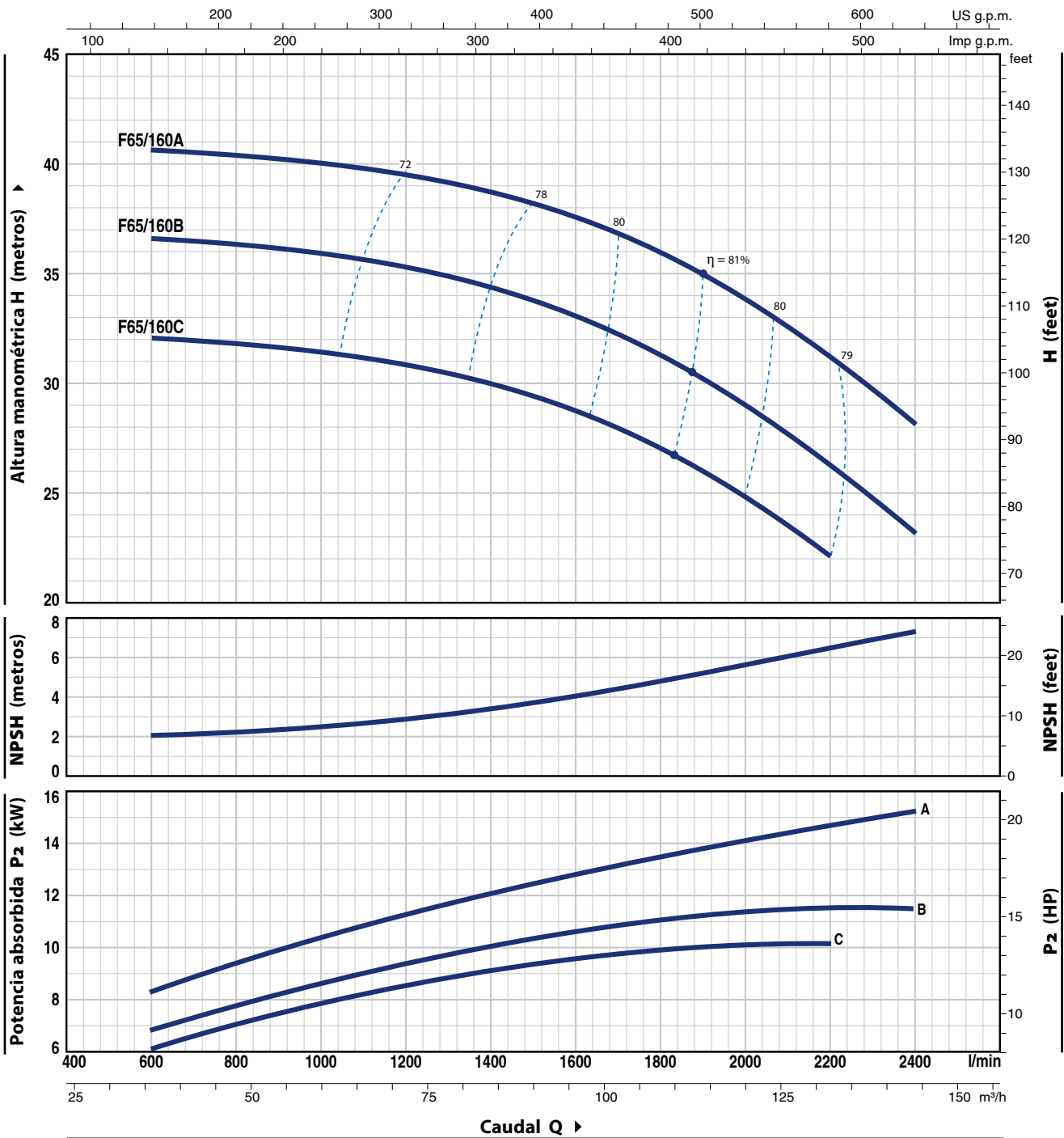

MODELO	POTENCIA (P ₂)		Q m ³ /h l/min	0	36	48	60	72	84	96	108	120	132	144
	kW	HP		0	600	800	1000	1200	1400	1600	1800	2000	2200	2400
F 65/160C *	9.2	12.5	H metros	32	32	32	32	32	30	29	27	25	22	
F 65/160B *	11	15		37	36.5	36.5	36	35.5	34	33	31	29	26	23
F 65/160A *	15	20		41	40.5	40.5	40	39.5	39	37.5	36	34	31	28

Q = Caudal H = Altura manométrica total HS = Altura de aspiración

Tolerancia de las curvas de prestación según EN ISO 9906 Grado 3B.

* Modelos solicitados bajo pedido

F65/200

CURVAS Y DATOS DE PRESTACIONES

60 Hz n = 3450 min⁻¹ HS = 0 m

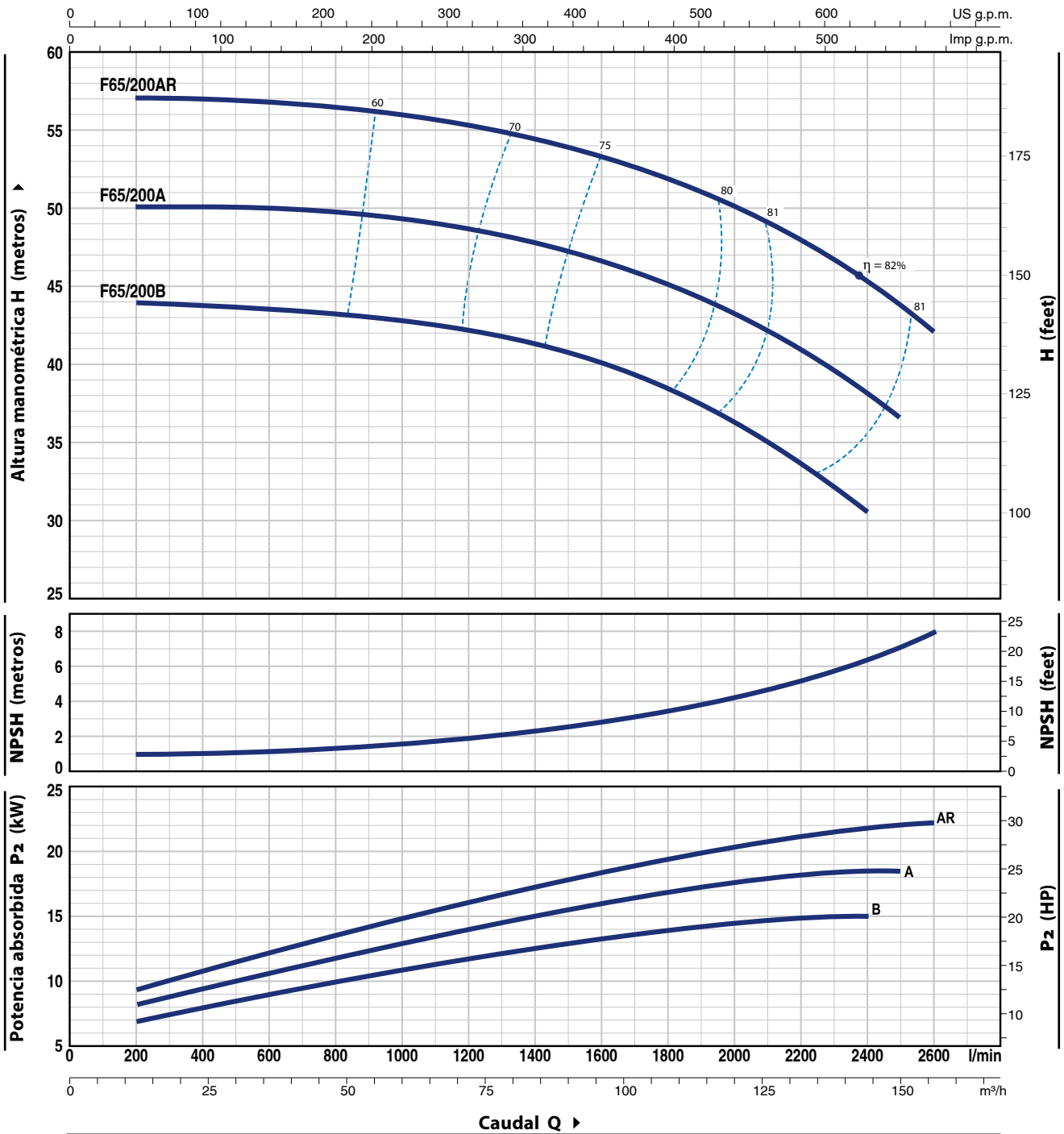

MODELO	POTENCIA (P ₂)		Q	m ³ /h														
	kW	HP		12	36	48	60	72	84	96	108	120	132	144	150	156		
Trifásica			l/min	200	600	800	1000	1200	1400	1600	1800	2000	2200	2400	2500	2600		
F 65/200B	15	20	H metros	44	43.5	43.3	43	42.5	41.5	40	38.5	36.5	34	30.5				
F 65/200A	18.5	25		50	50	50	49.5	49	48	46.5	45	43	41	38	36.5			
F 65/200AR	22	30		57	57	57	56	55.5	54.5	53.5	52	50	48	45.5	43.5	42		

Q = Caudal H = Altura manométrica total HS = Altura de aspiración

Tolerancia de las curvas de prestación según EN ISO 9906 Grado 3B.

CURVAS Y DATOS DE PRESTACIONES

60 Hz n = 3450 min⁻¹ HS = 0 m

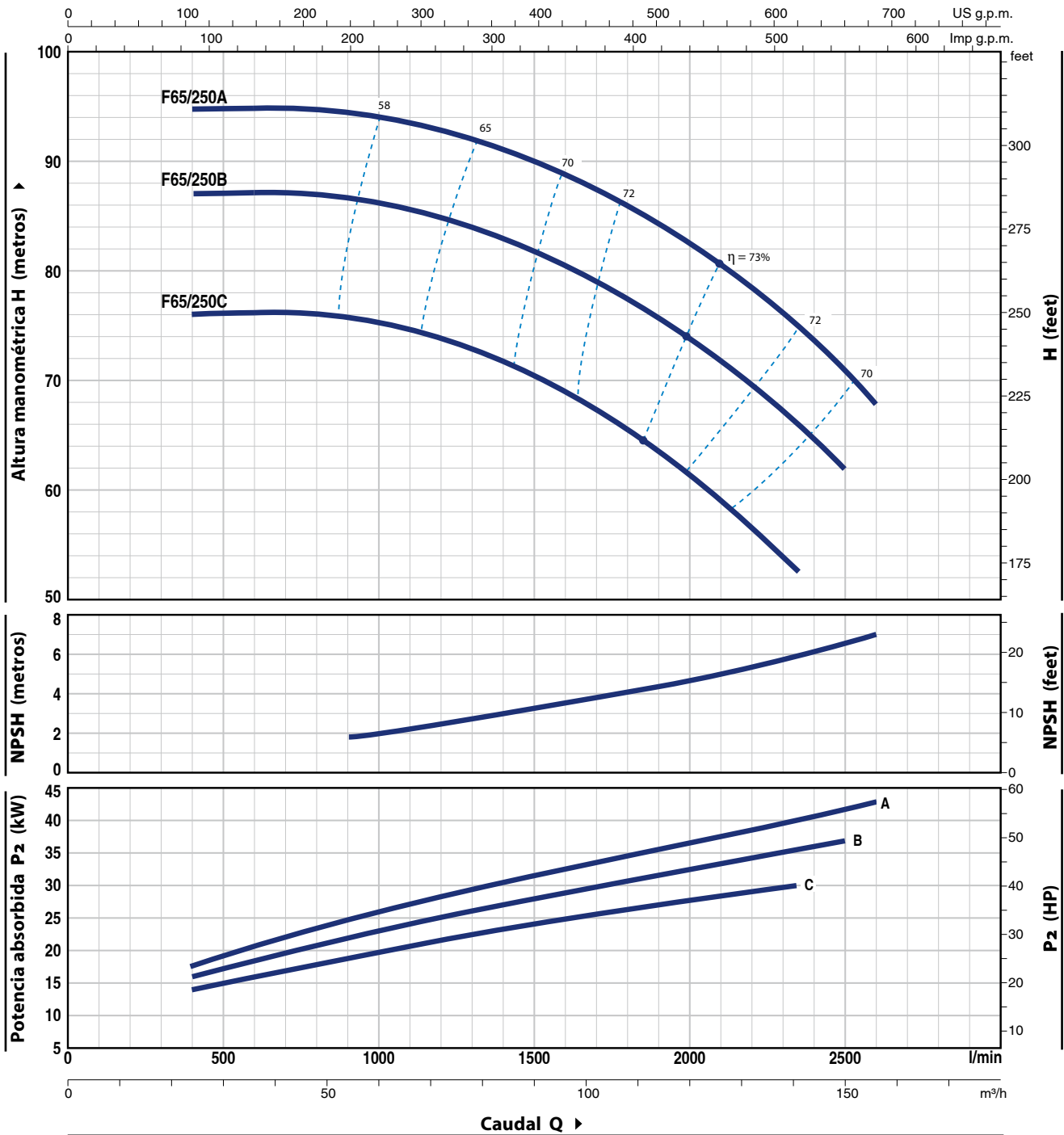

MODELO	POTENCIA (P ₂)		Q	H metros											
	kW	HP		m ³ /h	24	40	60	80	100	120	141	150	156		
Trifásica			l/min	400	667	1000	1333	1667	2000	2350	2500	2600			
F 65/250C *	30	40		76	76	75.5	72.5	68	61.5	53					
F 65/250B *	37	50		87	87	86	84	80	74	66.5	62				
F 65/250A *	45	60		95	95	94	92	88	82.5	75	71	68			

Q = Caudal H = Altura manométrica total HS = Altura de aspiración

Tolerancia de las curvas de prestación según EN ISO 9906 Grado 3B.

* Modelos solicitados bajo pedido

F80/160

CURVAS Y DATOS DE PRESTACIONES

60 Hz n = 3450 min⁻¹ HS = 0 m

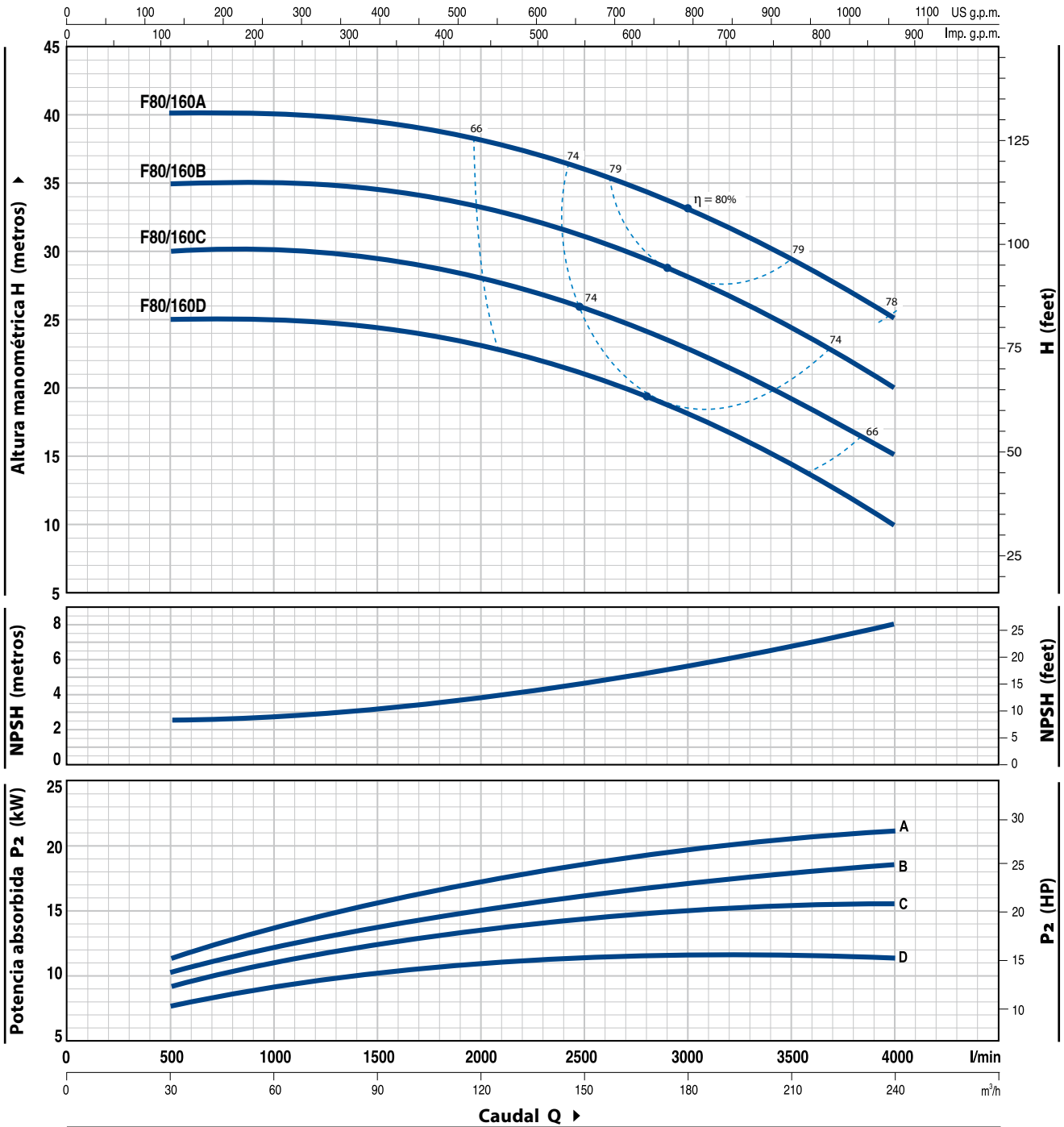

MODELO	POTENCIA (P ₂)		Q	Caudal Q											
	kW	HP		m ³ /h	0	30	60	90	120	150	180	210	240		
Trifásica			l/min	0	500	1000	1500	2000	2500	3000	3500	4000			
F 80/160D	11	15	H metros	25	25	25	24.5	23.5	21	18	14.5	10			
F 80/160C	15	20		30	30	30	29.5	28.5	26	23	19.5	15			
F 80/160B	18.5	25		35	35	35	34.5	33.5	31	28.5	24.5	20			
F 80/160A	22	30		40	40	40	39.5	38.5	36	33	29.5	25			

Q = Caudal H = Altura manométrica total HS = Altura de aspiración

Tolerancia de las curvas de prestación según EN ISO 9906 Grado 3B.

CURVAS Y DATOS DE PRESTACIONES

60 Hz n= 3450 min⁻¹ HS= 0 m

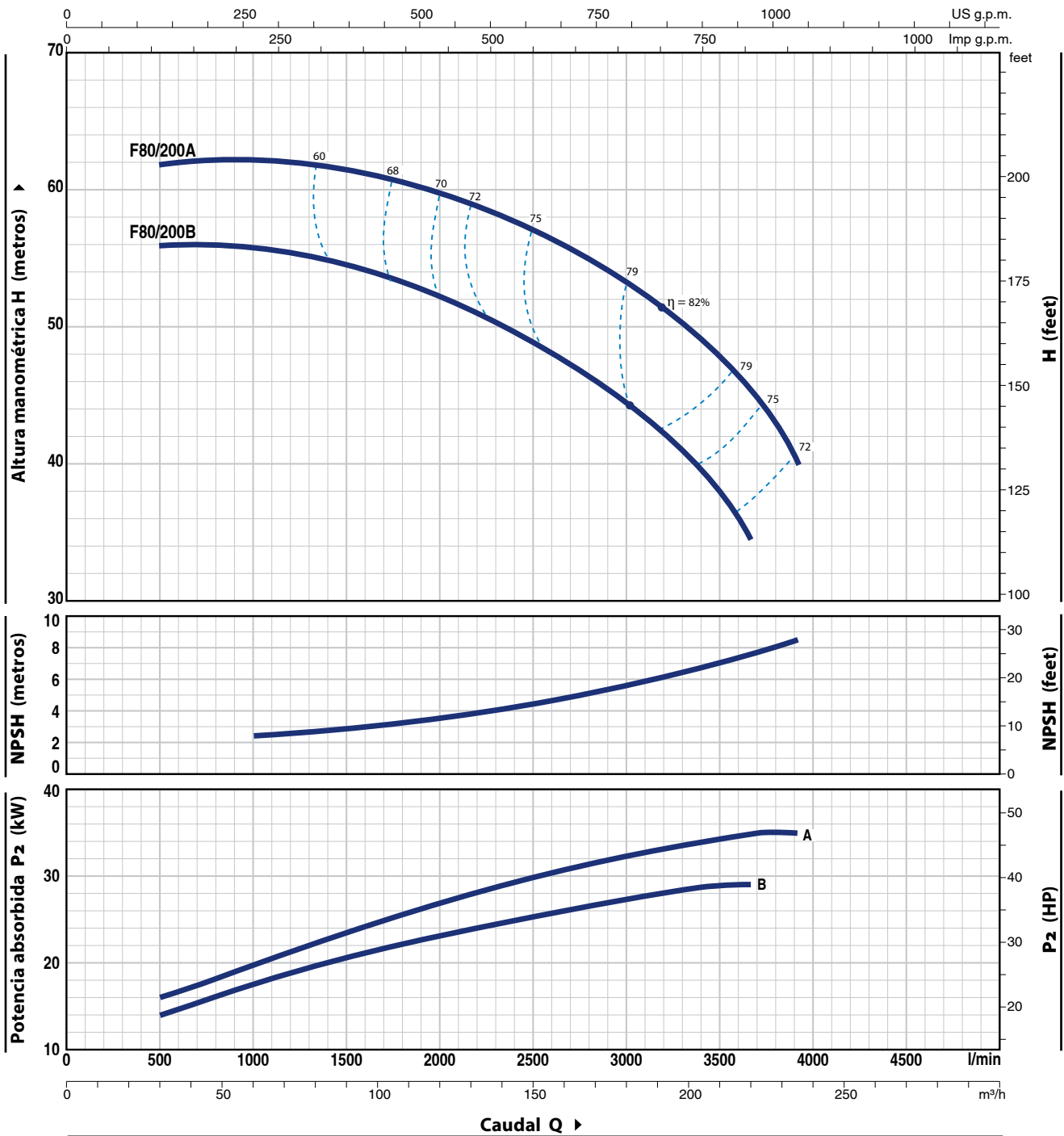

MODELO	POTENCIA (P ₂)		Q	Flow Rate (m³/h)						
	kW	HP		30	50	100	150	200	219	234
Trifásica			l/min	500	833	1667	2500	3333	3650	3900
F 80/200B *	30	40	H metros	56	56	54	49	41	34.5	
F 80/200A *	37	50		62	62	61	57	50	45.5	40

Q =Caudal H=Altura manométrica total HS = Altura de aspiración

Tolerancia de las curvas de prestación según EN ISO 9906 Grado 3B.

* Modelos solicitados bajo pedido

F80/250

CURVAS Y DATOS DE PRESTACIONES

60 Hz n = 3450 min⁻¹ HS = 0 m

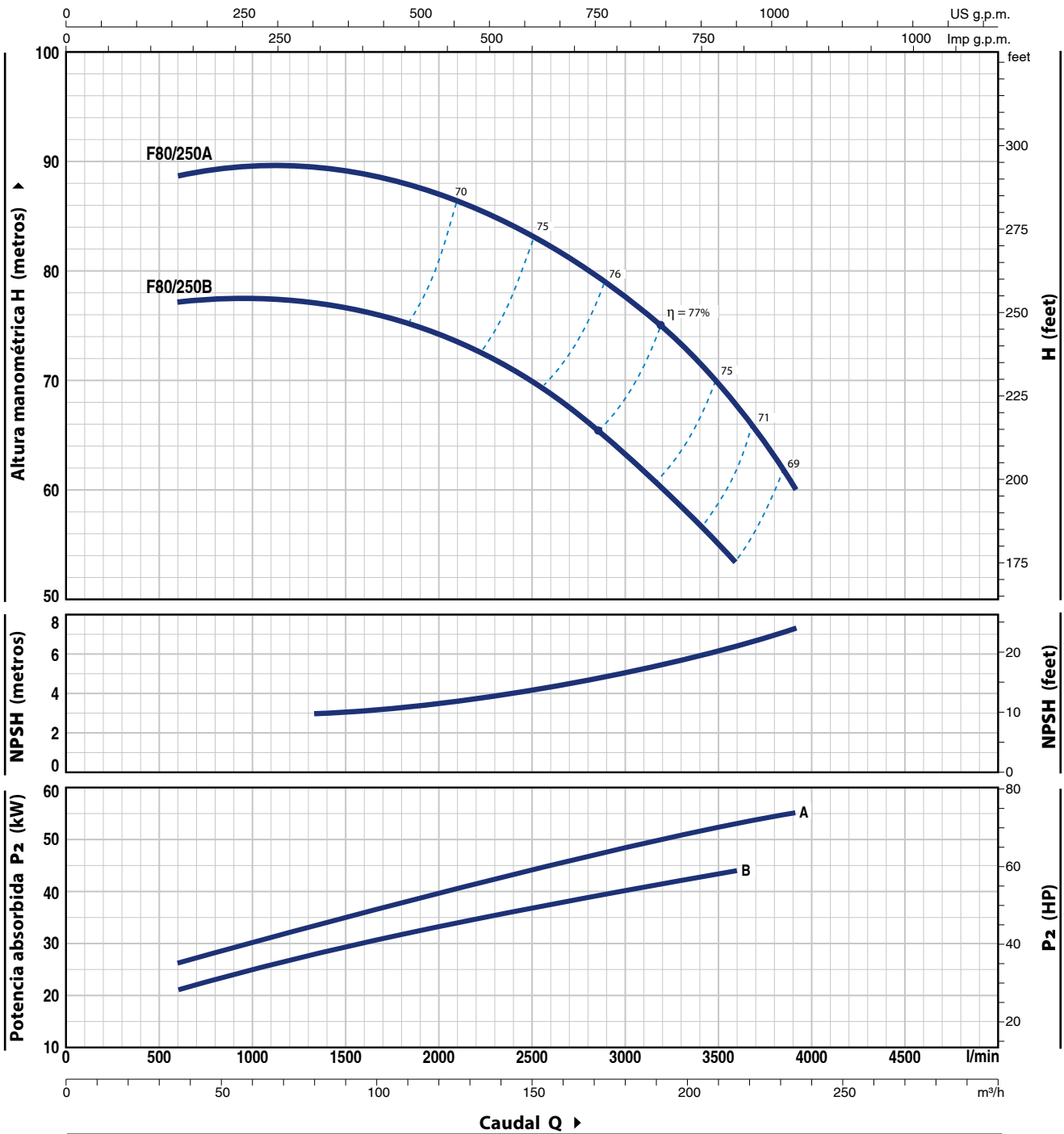

MODELO	POTENCIA (P ₂)		Q	Caudal						
	kW	HP		m ³ /h	l/min	m ³ /h	l/min	m ³ /h	l/min	
Trifásica				600	833	1667	2500	3333	3600	3900
F 80/250B *	45	60	H metros	77	77.5	76	70.5	58.5	54	
F 80/250A *	55	75		88.5	89.5	89	83	72	68	60

Q = Caudal H = Altura manométrica total HS = Altura de aspiración

Tolerancia de las curvas de prestación según EN ISO 9906 Grado 3B.

* Modelos solicitados bajo pedido

CURVAS Y DATOS DE PRESTACIONES

60 Hz n= 3450 min⁻¹ HS= 0 m

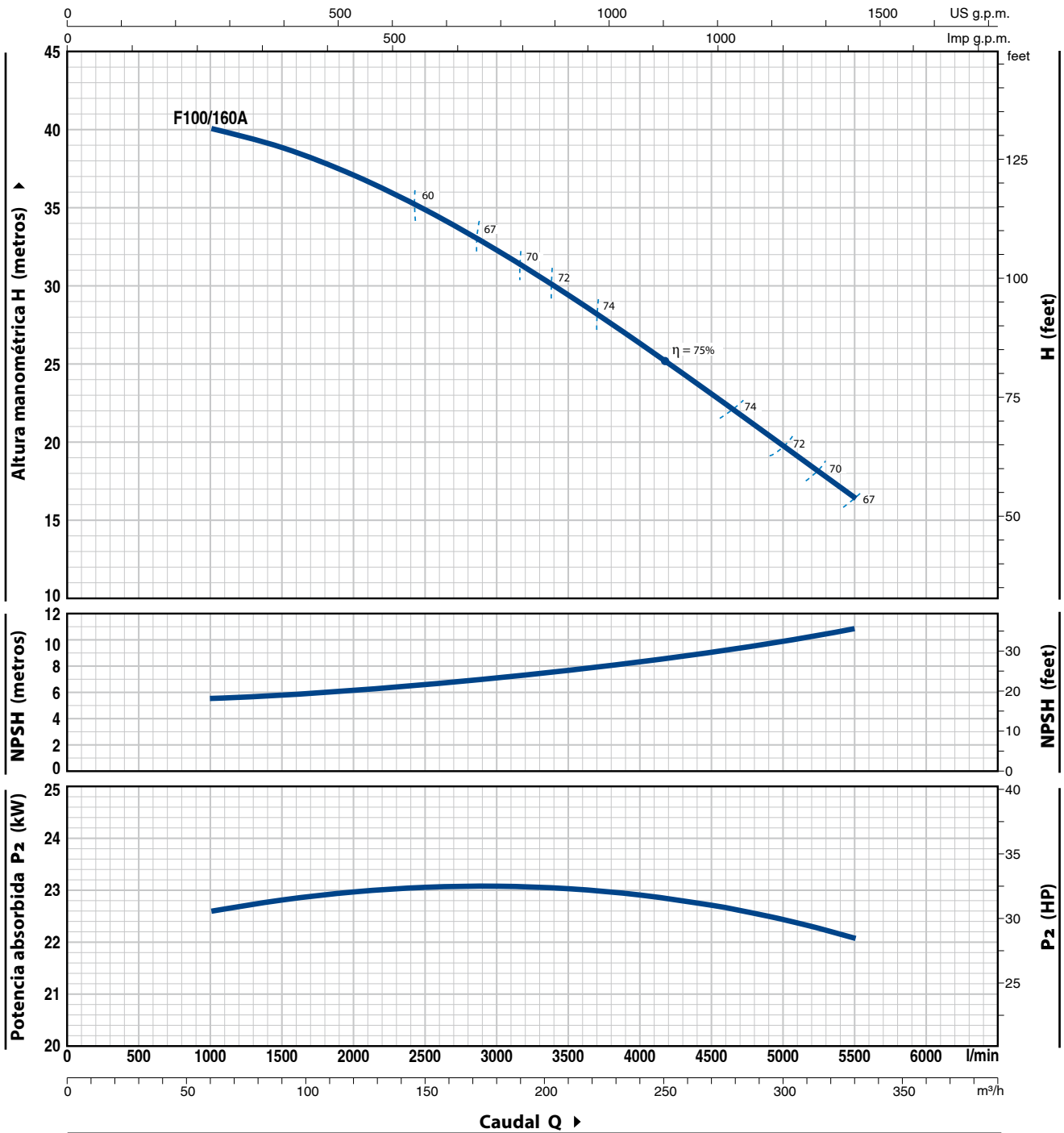

MODELO	POTENCIA (P ₂)		Q	m ³ /h												
	kW	HP		0	60	90	120	150	180	210	240	270	300	330		
Trifásica			l/min	0	1000	1500	2000	2500	3000	3500	4000	4500	5000	5500		
F 100/160A	22	30	H metros	40.5	40	39	37	35	32	29.5	26	23	19.5	16.5		

Q =Caudal H=Altura manométrica total HS = Altura de aspiración

Tolerancia de las curvas de prestación según EN ISO 9906 Grado 3B.

F100/200

CURVAS Y DATOS DE PRESTACIONES

60 Hz n = 3450 min⁻¹ HS = 0 m

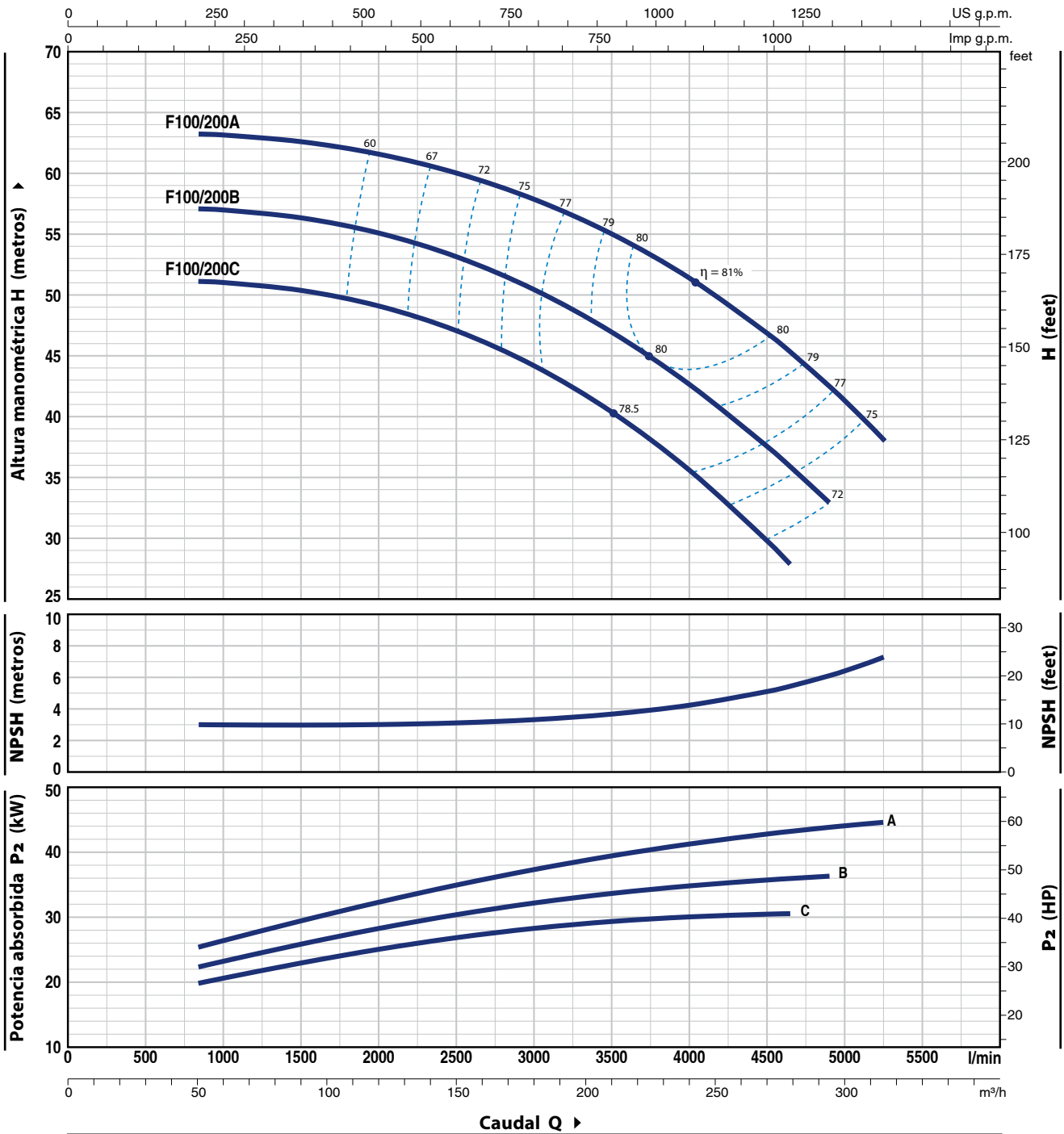

MODELO	POTENCIA (P ₂)		Q	Caudal Q												
	kW	HP		m ³ /h	0	50	96	150	180	210	240	279	294	300	315	
Trifásica			l/min	0	833	1600	2500	3000	3500	4000	4650	4900	5000	5250		
F 100/200C *	30	40	H metros	51	51	50	47	44	40.5	35.5	28					
F 100/200B *	37	50		57	57	56	53	50.5	47	42.5	36	33				
F 100/200A *	45	60		63	63	62.5	60	58	55	51.5	45	42.5	41.5	38		

Q = Caudal H = Altura manométrica total HS = Altura de aspiración

Tolerancia de las curvas de prestación según EN ISO 9906 Grado 3B.

* Modelos solicitados bajo pedido

CURVAS Y DATOS DE PRESTACIONES

60 Hz n = 3450 min⁻¹ HS = 0 m

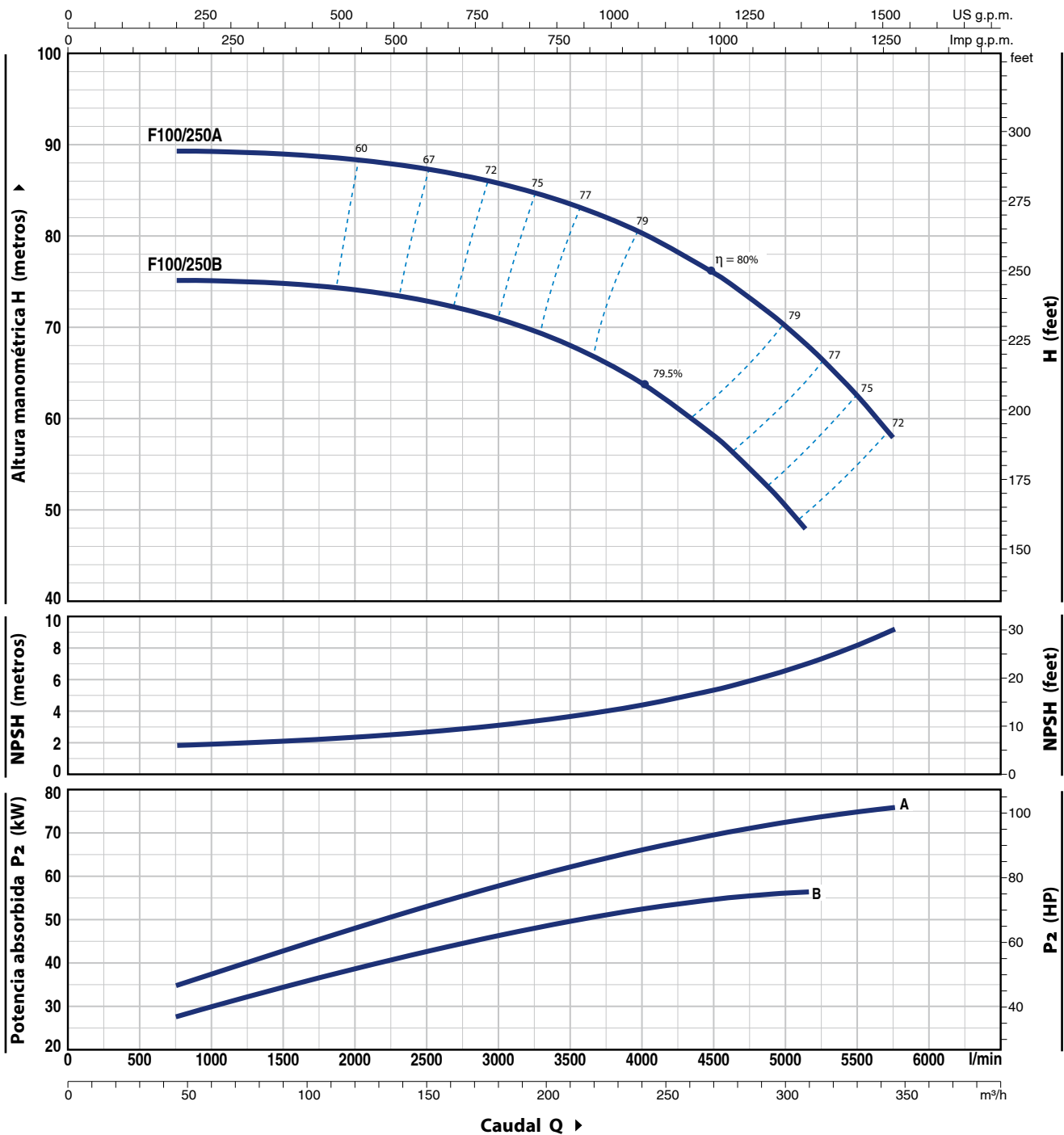

MODELO	POTENCIA (P ₂)		Q	Flow Rate (m³/h)										
	kW	HP		48	96	150	180	210	240	300	309	345		
Trifásica			l/min	800	1600	2500	3000	3500	4000	5000	5150	5750		
F 100/250B *	55	75	H metros	75	75	73	71	68	64	50.5	48			
F 100/250A *	75	100		89	89	87.5	86	83.5	80.5	70	68	58		

Q = Caudal H = Altura manométrica total HS = Altura de aspiración

Tolerancia de las curvas de prestación según EN ISO 9906 Grado 3B.

* Modelos solicitados bajo pedido

POS. COMPONENTE CARACTERÍSTICAS CONSTRUCTIVAS

1 CUERPO BOMBA	Hierro fundido con bocas de aspiración e impulsión con bridas				
2a TAPA	Hierro fundido para F32/160, F32/200, F40/125, F40/160, F40/200, F50/125, F50/160, F65/125				
2b SOPORTE	Hierro fundido para F32/250, F40/250, F50/200, F50/250, F65/160, F65/200, F65/250, F80/160, F80/200, F80/250, F100/160, F100/200, F100/250				
3 RODETE	Latón para F32/160, F32/200, F40/125, F40/160, F40/200, F50/125, F50/160 Hierro fundido para F32/250, F40/250, F50/200, F50/250, F65/125, F65/160, F65/200, F65/250, F80/160, F80/200, F80/250, F100/160, F100/200, F100/250				
4 EJE MOTOR	Acero inoxidable AISI 431				
5 SELLO MECANICO	Electrobomba	Sello	Eje	Materiales	
	Modelo	Modelo	Diámetro	Anillo fijo	Anillo móvil Elastómero
	F32/160, F40/125, F40/160, F50/125	FN-20	Ø 20 mm	Grafito	Cerámica NBR
	F32/200, F40/200, F50/160, F65/125	FN-24	Ø 24 mm	Grafito	Cerámica NBR
	F50/200, F65/160, F65/200, F80/160, F100/160	FN-32 NU	Ø 32 mm	Grafito	Cerámica NBR
	F32/250, F40/250, F50/250	FN-38	Ø 38 mm	Grafito	Cerámica NBR
	F65/250, F80/200, F80/250B, F100/200	FN-40 NU	Ø 40 mm	Grafito	Cerámica NBR
	F80/250A, F100/250	FH-45 NU	Ø 45 mm	Grafito	Cerámica NBR
6 RODAMIENTOS	Electrobomba	Modelo	Electrobomba	Modelo	
	F32/160C F40/160C	6206 ZZ-C3 / 6204 ZZ	F32/250 F50/200	6310 ZZ-C3 / 6308 ZZ-C3	
	F32/160B F50/125C		F40/250 F65/160		
	F40/125		F50/250 F80/160		
	Fm32/160B F32/160A	6206 ZZ-C3 / 6205 ZZ	F65/200 F100/160	6312 ZZ-C3 / 6212 ZZ-C3	
	Fm40/160C F40/160B		F65/250 F80/200		
	Fm50/125C F50/125B	6306 ZZ-C3 / 6206 ZZ-C3	F80/250B F100/200	6314 ZZ-C3 / 6313 ZZ-C3	
	F40/160A		F80/250A		
	F50/125A		F100/250		
	F32/200 F40/200	6307 ZZ-C3 / 6206 ZZ-C3	F100/250		
	F50/160 F65/125				
7 CONDENSADOR	Electrobomba	Capacidad			
	Monofásica	(220 V)			
	Fm32/160C	45 µF - 450 VL			
	Fm32/160B	70 µF - 450 VL			
	Fm40/125C	31.5 µF - 450 VL			
	Fm40/125B	45 µF - 450 VL			
	Fm40/125A	70 µF - 450 VL			
	Fm40/160C	70 µF - 450 VL			
	Fm50/125C	70 µF - 450 VL			
8 MOTOR ELÉCTRICO	Fm: monofásica 220 V - 60 Hz con protección térmica incorporada en el bobinado (hasta 1.5 kW) F: trifásica 220/380 V - 60 Hz o 220/440 V - 60 Hz				
	<ul style="list-style-type: none"> Las electrobombas trifásicas están equipadas con motores de alto rendimiento en clase IE3 (IEC 60034-30) 				
	- Aislamiento: clase F - Protección: IP 55				

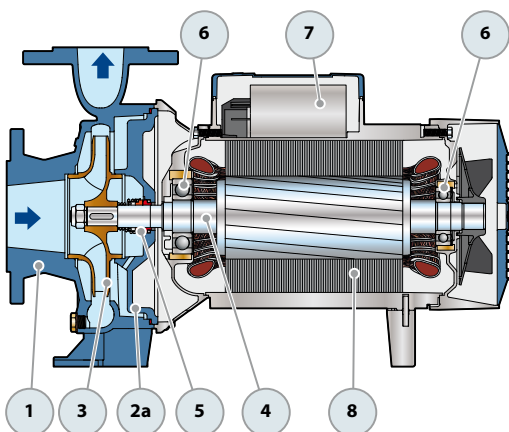

Versión monofásica

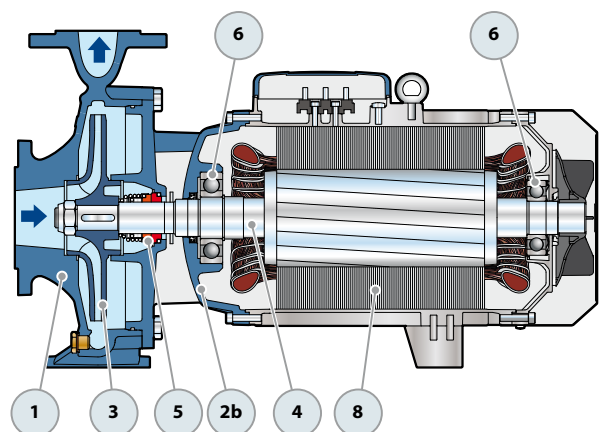

Versión trifásica

CONSUMO EN AMPERIOS

MODELO	TENSIÓN
Monofásica	220 V
Fm 32/160C	11.0 A
Fm 32/160B	15.0 A
Fm 40/125C	8.0 A
Fm 40/125B	11.0 A
Fm 40/125A	14.5 A
Fm 40/160C	17.0 A
Fm 50/125C	17.0 A

MODELO	TENSIÓN				
	220 V	380 V	660 V	220 V	440 V
Trifásica					
F 32/160C	7.8 A	4.5 A	2.6 A	6.0 A	3.9 A
F 32/160B	10.0 A	5.8 A	3.4 A	7.6 A	4.5 A
F 32/160A	12.1 A	7.0 A	4.0 A	12.1 A	6.5 A
F 32/200C	18.9 A	10.9 A	6.3 A	18.5 A	12.3 A
F 32/200B	24.0 A	13.9 A	8.0 A	22.0 A	13.8 A
F 32/200A	27.0 A	15.6 A	9.0 A	27.0 A	18.0 A
F 32/200BH	13.5 A	7.8 A	4.5 A	12.7 A	7.7 A
F 32/200AH	18.0 A	10.4 A	6.0 A	17.5 A	11.0 A
F 32/250C	38.0 A	22.0 A	12.7 A	39.8 A	20.0 A
F 32/250B	43.0 A	25.0 A	14.5 A	36.5 A	21.0 A
F 32/250A	57.0 A	33.0 A	19.1 A	60.0 A	34.0 A
F 40/125C	6.0 A	3.5 A	2.0 A	6.2 A	3.5 A
F 40/125B	8.1 A	4.7 A	2.7 A	6.4 A	4.1 A
F 40/125A	10.0 A	5.8 A	3.4 A	9.5 A	5.5 A
F 40/160C	10.0 A	5.8 A	3.4 A	8.7 A	5.0 A
F 40/160B	12.9 A	7.5 A	4.3 A	12.1 A	6.5 A
F 40/160A	20.9 A	12.1 A	7.0 A	19.5 A	12.5 A
F 40/200B	28.5 A	16.5 A	9.5 A	22.7 A	15.4 A
F 40/200A	30.9 A	17.8 A	10.3 A	28.5 A	21.8 A
F 40/250C	38.0 A	22.0 A	12.7 A	39.8 A	20.0 A
F 40/250B	43.0 A	25.0 A	14.5 A	36.5 A	21.0 A
F 40/250A	57.0 A	33.0 A	19.1 A	60.0 A	34.0 A
F 50/125C	10.7 A	6.2 A	3.6 A	9.8 A	6.7 A
F 50/125B	11.3 A	6.5 A	3.8 A	12.1 A	6.5 A
F 50/125A	18.2 A	10.5 A	6.1 A	19.0 A	12.5 A
F 50/160C	17.7 A	10.3 A	6.0 A	16.4 A	12.5 A
F 50/160B	21.0 A	12.0 A	6.9 A	20.8 A	13.5 A
F 50/160A	28.0 A	16.5 A	9.5 A	26.7 A	17.5 A
F 50/200C	46.0 A	26.5 A	15.3 A	47.0 A	25.0 A
F 50/200B	56.0 A	32.0 A	18.5 A	58.0 A	30.0 A
F 50/200A	67.5 A	39.0 A	22.5 A	70.0 A	36.0 A
F 50/200AR	87.0 A	51.0 A	29.5 A	78.0 A	45.0 A

MODELO	TENSIÓN				
	220 V	380 V	660 V	220 V	440 V
Trifásica					
F 50/250D	32.5 A	18.5 A	10.7 A	29.5 A	17.0 A
F 50/250C	44.0 A	25.0 A	14.5 A	36.5 A	21.0 A
F 50/250B	52.0 A	30.0 A	17.3 A	50.0 A	26.0 A
F 50/250A	64.0 A	37.0 A	21.4 A	66.0 A	36.0 A
F 50/250AR	82.0 A	48.0 A	27.7 A	76.0 A	42.0 A
F 65/125C	18.0 A	10.4 A	6.0 A	19.5 A	12.5 A
F 65/125B	22.5 A	13.0 A	7.5 A	22.0 A	13.8 A
F 65/125A	28.8 A	16.6 A	9.6 A	32.0 A	19.5 A
F 65/160C	37.0 A	21.5 A	12.4 A	37.0 A	24.0 A
F 65/160B	47.0 A	27.0 A	15.6 A	48.0 A	26.0 A
F 65/160A	55.0 A	32.0 A	18.5 A	53.0 A	28.0 A
F 65/200B	56.2 A	32.5 A	18.8 A	58.5 A	32.0 A
F 65/200A	73.5 A	42.5 A	24.6 A	70.0 A	36.0 A
F 65/200AR	97.0 A	56.0 A	32.4 A	79.0 A	48.0 A
F 65/250C	110.0 A	64.0 A	37.0 A	100.0 A	55.0 A
F 65/250B	121.0 A	70.0 A	40.5 A	120.0 A	63.0 A
F 65/250A	153.0 A	88.0 A	50.9 A	140.0 A	75.0 A
F 80/160D	45.0 A	26.0 A	15.0 A	50.0 A	27.0 A
F 80/160C	59.0 A	34.0 A	19.7 A	60.0 A	30.0 A
F 80/160B	66.0 A	38.0 A	22.0 A	66.0 A	36.0 A
F 80/160A	93.5 A	54.0 A	31.2 A	79.0 A	48.0 A
F 80/200B	106.0 A	61.0 A	35.3 A	-	-
F 80/200A	121.0 A	70.0 A	40.5 A	111.0 A	58.0 A
F 80/250B	153.0 A	88.0 A	50.9 A	-	-
F 80/250A	194.0 A	112.0 A	64.7 A	-	-
F 100/160A	90.0 A	52.0 A	30.1 A	78.0 A	45.0 A
F 100/200C	111.0 A	64.0 A	37.0 A	-	-
F 100/200B	121.0 A	70.0 A	40.5 A	120.0 A	63.0 A
F 100/200A	153.0 A	88.0 A	50.9 A	140.0 A	75.0 A
F 100/250B	163.0 A	94.0 A	54.3 A	-	-
F 100/250A	228.0 A	132.0 A	76.3 A	240.0 A	120.0 A

DIMENSIONES Y PESOS

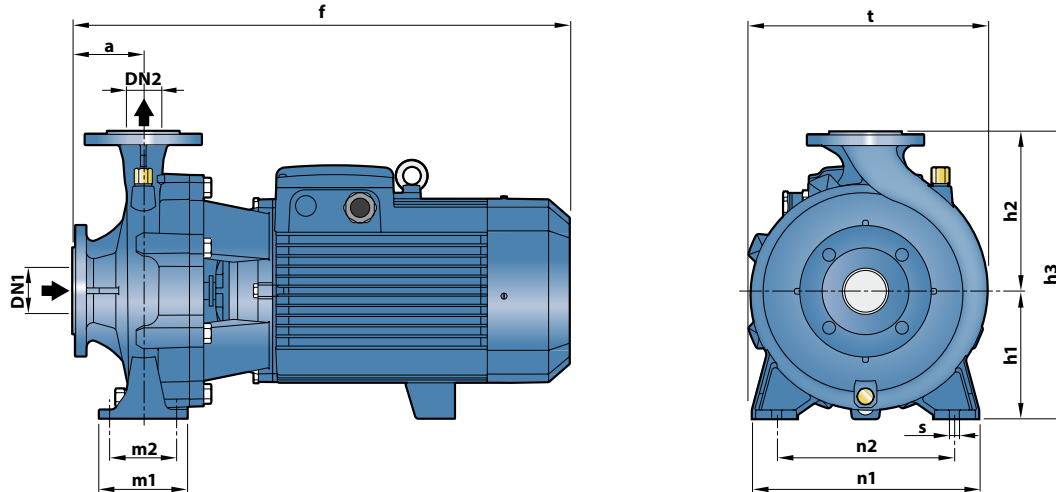

MODELO		DIMENSIONES mm													kg							
Monofásica	Trifásica	DN1	DN2	a	f	h1	h2	h3	t	n1	n2	m1	m2	s	1~	3~						
Fm 32/160C	F 32/160C	50	32	80	419	160	160	292	240	245	190	100	70	14	32.6	32.3						
Fm 32/160B	F 32/160B				448/432										42.3	35.2						
-	F 32/160A				448										-	38.7						
-	F 32/200C				469										-	46.3						
-	F 32/200B				515										-	51.8						
-	F 32/200A				160										180	340	273	95	-	56.9		
-	F 32/200BH				469										-	42.0						
-	F 32/200AH				-										-	45.8						
-	F 32/250C				-										-	105.5						
-	F 32/250B				100										606	180	225	405	325	320	250	125
-	F 32/250A	701	-	121.0																		
Fm 40/125C	F 40/125C	65	40	80	421	132	160	292	244	210	160	100	70	14	31.5	29.9						
Fm 40/125B	F 40/125B				457/439										33.0	32.4						
Fm 40/125A	F 40/125A				455/439										42.7	32.6						
Fm 40/160C	F 40/160C				448										38.3	33.4						
-	F 40/160B				465										-	38.9						
-	F 40/160A				535										-	43.6						
-	F 40/200B				160										180	340	277	265	212	-	53.0	
-	F 40/200A				606										-	59.0						
-	F 40/250C				701										-	104.0						
-	F 40/250B				180										225	405	329	320	250	125	95	-
-	F 40/250A	104.0																				
Fm 50/125C	F 50/125C	65	50	100	465/451	160	160	292	242	240	190	100	70	14	36.8	35.1						
-	F 50/125B				465										-	38.5						
-	F 50/125A				484										-	42.8						
-	F 50/160C				489										-	47.3						
-	F 50/160B				535										180	340	273	-	100	70	-	52.8
-	F 50/160A				616										-	57.6						
-	F 50/200C				616										160	-	265	212	-	100.0		
-	F 50/200B				711										-	115.0						
-	F 50/200A				711										200	360	316.5	-	-	127.2		
-	F 50/200AR				743										-	141.0						
-	F 50/250D	605	-	104.2																		
-	F 50/250C	-	-	105.0																		
-	F 50/250B	701	180	225	405	333	320	250	-	121.0												
-	F 50/250A	134.2																				
-	F 50/250AR	733	-	147.0																		
-	F 65/125C	511	-	53.2																		
-	F 65/125B	557	180	340	292	-	280	212	-	58.3												
-	F 65/125A	620	160	-	280	212	-	125	95	-	63.0											
-	F 65/160C	620	160	-	280	212	-	125	95	-	98.5											
-	F 65/160B	716	200	360	295	-	-	-	-	114.0												
-	F 65/160A	716	-	119.3																		
-	F 65/200B	718	-	132.1																		
-	F 65/200A	751	-	145.3																		
-	F 65/200AR	751	-	103.1																		
-	F 80/160D	652	180	225	405	-	320	250	-	120.0												
-	F 80/160C	747	-	125	330	-	-	-	-	133.8												
-	F 80/160B	779	-	144.0																		
-	F 80/160A	779	-	144.0																		
-	F 100/160A	125	100	125	790	200	280	480	382	360	280	160	120	18	-	164.0						

DIMENSIONES Y PESOS

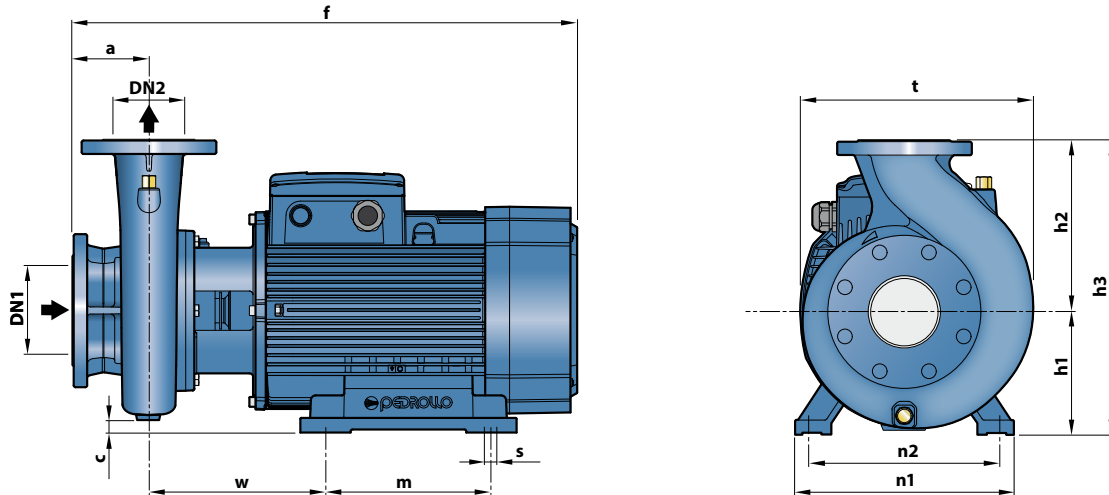

MODELO	DIMENSIONES mm														kg
Trifásica	DN1	DN2	a	f	h1	h2	h3	c	t	n1	n2	w	m	s	3~
F 65/250C	80	65	100	796	201	250	451	16	363	360	318	269.5	305	18.5	208.0
F 65/250B				847											226.0
F 65/250A				847											246.2
F 80/200B	100	80	125	824	280	280	450	26	360	490	400	294	350	24	197.4
F 80/200A				875											223.0
F 80/250B				872											240.0
F 80/250A	125	100	140	1015	250	280	620	55	490	485	406	313	350	24	547.0
F 100/200C				826											214.4
F 100/200B				875											234.2
F 100/200A	125	100	140	877	201	280	481	0	391	360	318	271	305	18.5	232.8
F 100/250B				551.2											
F 100/250A															544.3

BRIDAS DE LAS BOCAS

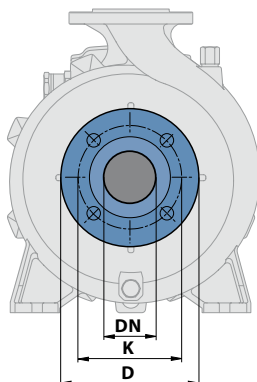

CONTOBRIDAS

(SE PUEDE PEDIR A PARTE)

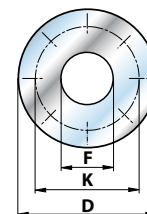

DN BRIDAS mm	D mm	K mm	ORIFICIOS	
			Nº	Ø (mm)
32	140	100	4	18
40	150	110		
50	165	125		
65	185	145		
80	200	160		
100	220	180	8	
125	250	210		

DN BRIDAS mm	F CONTOBRIDAS	D mm	K mm	ORIFICIOS	
				Nº	Ø (mm)
32	1¼"	140	100	4	18
40	1½"	150	110		
50	2"	165	125		
65	2½"	185	145		
80	3"	200	160		
100	4"	220	180	8	
125	5"	250	210		